



ADAPT-SOG 20
USER MANUAL

for

**POST-TENSIONED FOUNDATION SLABS
ON EXPANSIVE OR COMPRESSIBLE SOIL**

Copyright© 2020

LIST OF CONTENTS

1	Overview	3
2	Program Description	5
3	DATA GENERATION AND EXECUTION.....	7
3.1	3.1 Structural Model.....	7
3.2	3.2 Soil Support	8
3.3	3.3 Design Criteria	9
3.4	3.4 Applied Load from Structure Above	12
3.5	3.5 Applied Displacement from the Soil	12
3.6	3.6 Load Combination	12
3.7	3.7 Analysis of the Structure	13
3.8	3.8 Creation of Design Strips and Design Check	13
3.9	3.9 Reports.....	19
4	THEORY AND DESIGN PROCEDURE.....	21
4.1	4.1 Background	21
4.2	4.2 Center Lift.....	21
4.3	4.3 Edge Lift.....	25
4.3.1	4.3.1 Design Procedure.....	25
4.3.2	4.3.2 Edge Lift Calculation Δ	28
4.3.2.1	4.3.2.1 Calculation of delta for ribbed foundations	30
4.3.2.2	4.3.2.2 Calculation of delta for uniform Slabs	30
5	DESIGN OF POST-TENSIONED SLABS ON EXPANSIVE SOIL USING THE ENHANCED PTI METHOD.....	33
5.1	5.1 Overview	33
5.2	5.2 Background	33
5.2.1	5.2.1 Scope of Application	33
5.2.2	5.2.2 Soil Response to Variations in the Moisture Content	35
5.2.3	5.2.3 Response of the Slab to Variations in the Moisture Content of the Soil.....	36
5.2.3.1	5.2.3.1 Center lift condition	36
5.2.3.2	5.2.3.2 Edge lift condition	37
5.3	5.3 PTI DESIGN METHOD	37
5.4	5.4 ENHANCED PTI (E-PTI) METHOD	39
5.4.1	5.4.1 Analysis Tool.....	40
5.4.2	5.4.2 Soil Parameters and Modeling	40
5.4.3	5.4.3 Analysis.....	42
5.4.4	5.4.4 Determination of Design Values.....	42
5.4.5	5.4.5 Comparison of Design Values with Allowable Values	43
5.5	5.5 Illustrative Design Example	44

5.5.1	Geometry.....	45
5.5.2	Post-Tensioning	45
5.5.3	Material.....	48
5.5.4	Loading.....	48
5.5.5	Design.....	48
5.5.5.1	Design Requirements	48
5.5.5.2	Center Lift Design.....	49
5.5.5.2.1	DEFLECTION CHECK.....	49
5.5.5.2.2	STRESS CHECK DUE TO BENDING	51
5.5.5.2.3	STRESS CHECK DUE TO SHEAR.....	53
5.5.5.2.4	SOIL PRESSURE	55
5.5.5.2.5	EQUILIBRIUM CHECK.....	57
5.5.5.2.6	EDGE LIFT DESIGN	57
5.6	COMMENTS.....	62
5.6.1	Reference Example	62
5.6.2	Comments on PTI and E-PTI Methods	63
5.6.2.1	Uniform Thickness	63
5.6.2.2	Straight Tendons at Centroid	66
5.6.2.3	One Soil Property for All Projects	66
5.6.2.4	Load on Perimeter Only	66
5.6.2.5	Rectangular Slabs.....	66
5.6.2.6	Slabs with Minimum Width of 24 ft.....	67
5.6.2.7	One Representative Design Value	67
5.6.2.8	Shear Due to Profiled Tendons.....	67
5.6.2.9	Check for Floating Slabs	67
5.7	CONCLUDING REMARKS.....	70
5.8	APPENDIX	70
6	REFERENCES	71

1 Overview

ADAPT-SOG is an optional module of the ADAPT-BUILDER software platform. It works within the structural modeling and analysis environment of ADAPT-BUILDER. As such, ADAPT-SOG relies heavily on the documentation of ADAPT-BUILDER for the generation of the input data, processing of the input data, analysis, and reporting of the solutions obtained.

This manual is limited to program features and topics that are specific to SOG. Generation of the foundation structure, application of loading, meshing and analysis are all described in other documentation included with the software. Program documentation can be found by going to *Help* → *Documentation* within the program.

2 Program Description

ADAPT-SOG is a computer program, based on Finite Element Method (FEM) and developed specifically for the analysis and design of post-tensioned ground supported Slabs. The soil support can be either expansive or compressible.

The characteristic feature of SOG is that the foundation Slab receives its critical loading primarily from changes in the volume of the soil support. Variations in moisture of the underlying soil, and consequently heaving or reduction of volume in the soil, form the governing load on the foundation Slab.

The application of the program is primarily for low-rise residential, or light commercial buildings. In these applications, loads from above the Slab are low in magnitude, and the foundation soil is generally not prepared to any significant extent, in order to minimize its volume change.

The distinguishing feature of SOG from the traditional mat foundation is that the latter receives heavy loading through Columns and Walls above it. The function of a mat is to spread and distribute the loading from above over the soil below to an intensity acceptable for the long-term stability of the soil. In summary, the mat acts to distribute the load over a wide area. Apart from application, the design concept and procedure of a mat foundation are different from SOG. Mat foundations are generally used in high-rise buildings combined with soils having poor bearing capacity or high consolidation characteristics. For the design of mat foundations, ADAPT-MAT is used.

For some loading conditions, a SOG or mat foundation Slab can lose partial contact with the soil support. The BUILDER programs are coded such as to recognize the loss of contact with soil and allow for it in the program's analysis and design process.

There are several methods available for the design of SOG. The Post-Tensioning Institute's (PTI) method is one. One of the options of ADAPT-SOG is to perform a design according to an Enhanced procedure of the Post-Tensioning Institute's method (E-PTI). Obviously, ADAPT-SOG can also be used to design a Slab using the non-enhanced procedure of the PTI method or the other options of design.

3 Data Generation and Execution

3.1 Structural Model

The Slab geometry is created using the ADAPT-Modeler feature of the BUILDER platform. The MODELER gives you the option to generate the geometry of the foundation Slab either by importing an existing drawing (files with DWG/DXF format) or drawing the Slab graphically using the powerful drafting capability of the MODELER program. **Figure 3.1-1** shows several geometry examples of ground supported Slabs.

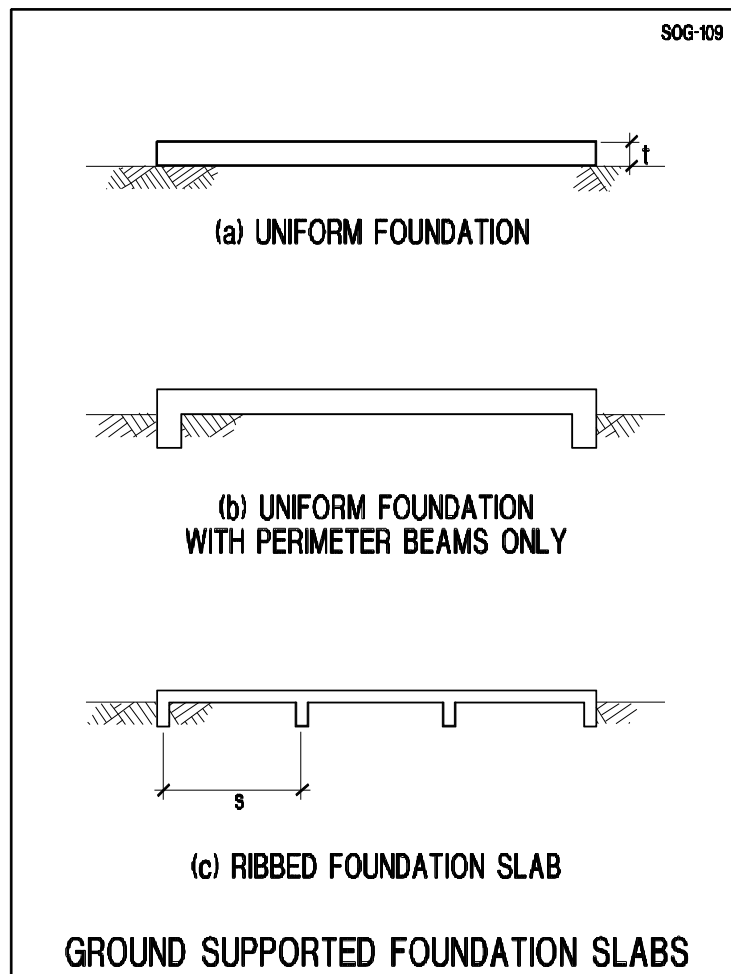
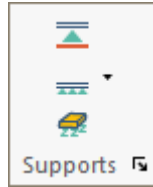

Figure 3.1-1 - Examples of SOG Geometry

Note that Beams and post-tensioned Tendons of a SOG can be modeled as they occur in the actual structure. In addition to Beams, Openings, enlarged pads below interior Columns, steps in the Slab and other irregularities on the floor plan, a section can be represented in the structural model and accounted for in the analysis and design.

3.2 Soil Support

The soil support is modeled as a Winkler foundation. The foundation is represented by a series of elastic springs. As a user, you need to specify the region below the Slab covered by soil and the soil's bulk modulus (also referred to as modulus of subgrade reaction). In many instances, the soil property is expressed in terms of its modulus of elasticity. **Table 3.2-1** from reference [Bowles, 1988] may be used as a guide to estimate the bulk modulus of soil. In the absence of more accurate information, many engineers use a bulk modulus of 100 pci (2.714×10^{-2} N/mm³) for post-tensioned Slabs on expansive soil.



The *Supports* panel of the *Model* ribbon offers options for three types of foundation support. The button at the bottom is used to represent soil over an area to be specified by you. The first and second are non-sinking point and line supports respectively. These two are not used for common foundation Slabs.

Table 3.2-1 - Approximate Relationship Between Bulk Modulus and Modulus of Elasticity of Selected Soils

Soil Type	k_s kcf	k_s kN/m ³
Loose sand	30-100	4800-16,000
Medium dense sand	60-500	9600-80,000
Dense sand	400-800	64,000-128,000
Clayey medium dense sand	200-500	32,000-80,000
Silty medium dense sand	150-300	24,000-48,000
Clayey soil:		
$q_u \leq 200$ kPa (4-ksf)	75-150	12,000-24,000
$200 < q_u \leq 400$ kPa	150-300	24,000-48,000
$q_u > 800$ kPa	>300	> 48,000

The input dialog box for soil type and property is shown in **Fig. 3.2-1**. The bulk modulus of soil shall be entered in the data field k_s . In practically all conditions, "Compression only" soil type will be selected. The other option available in the combo box of Spring/Soil type is: "Compression and Tension." The data fields for "Label" and "Group" are explained in other ADAPT-BUILDER documentation.

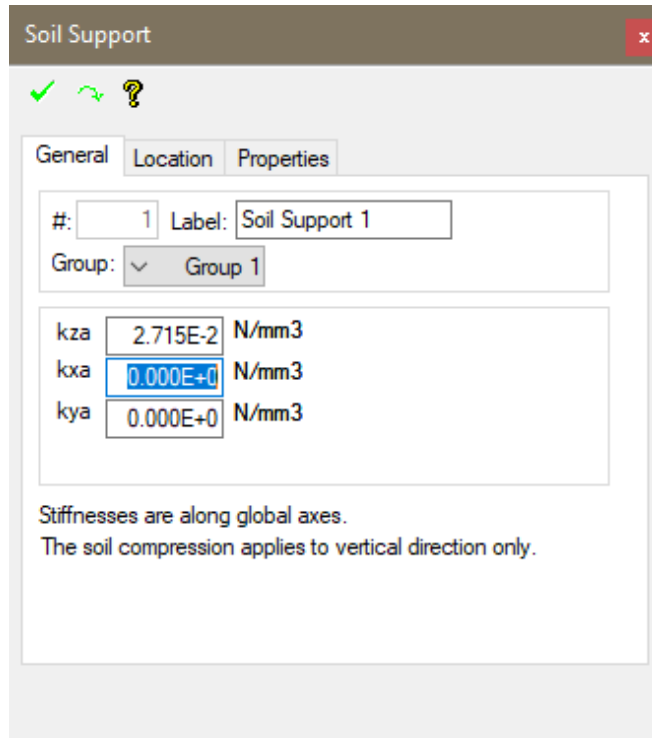

Figure 3.2-1 - Input Dialog Box for Soil Type and Property

The foundation Slab may be supported on more than one type of soil. In this case, each soil region is drawn as a separate area with its own properties.

3.3 Design Criteria

The design criteria are accessible through the *Criteria* ribbon *Design Criteria* panel. These criteria are grouped as indicated by the tab headings in **Fig. 3.3-1**. The default values of the design parameters are based on the references [PTI, 1996; IBC 2000; UBC, 1997]. You also have the option to check your design against allowable stress and deflection values that you will define in this input dialog window.

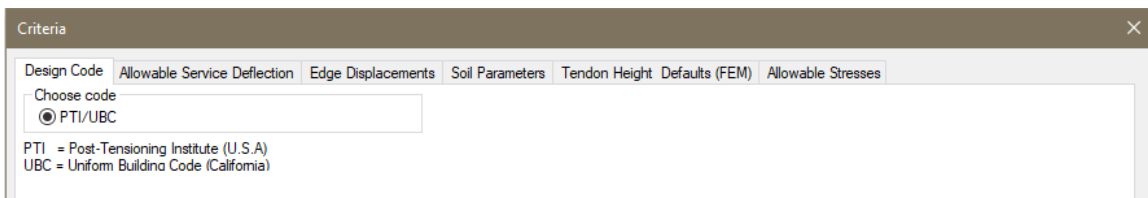

Figure 3.3-1 - Design Criteria

The soil parameters for either or both loading conditions of center lift and edge lift are entered in **Fig. 3.3-2**.

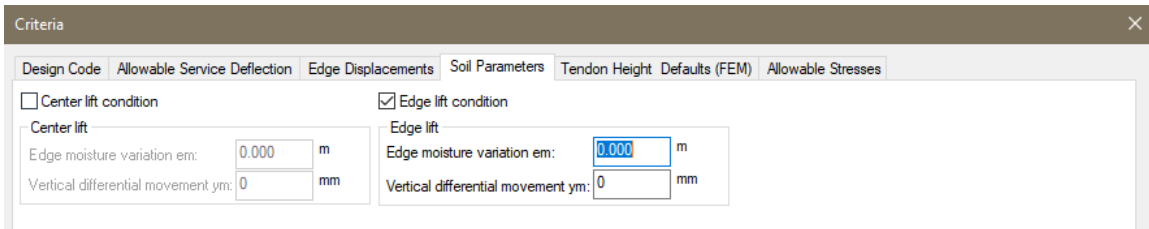

Figure 3.3-2 - Soil Parameters

For the edge lift condition, the value of edge displacement (Δ) to be applied to the Slab boundary is calculated using the PTI formula (refer to **Chapter 4**). The input parameters for the calculation of Δ are: (**Fig. 3.3-3**, **Fig. 3.3-4**, and **Fig. 4.3.2-1**)

- W = Total width of the edge for which Δ is to be calculated;
- L = Length of Slab normal to the edge for which Δ is being calculated, but not larger than $4W$;
- H = Depth of ribs;
- t = Slab thickness;
- P = Total load along the Slab edge (not factored);
- S = Spacing between the ribs; and
- K = A factor used for conversion of Slabs of uniform thickness to an equivalent ribbed Slab, when using the PTI method (see **Chapter 4**).

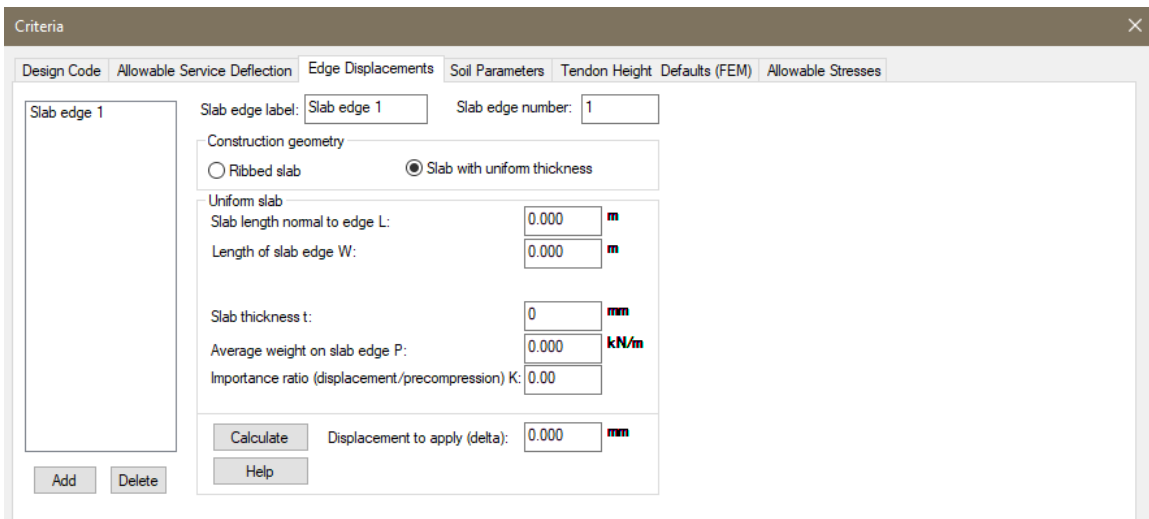

Figure 3.3-3 - Input Dialog Window for the Calculation of Applied Edge Displacement Δ for Slabs with Uniform Thickness

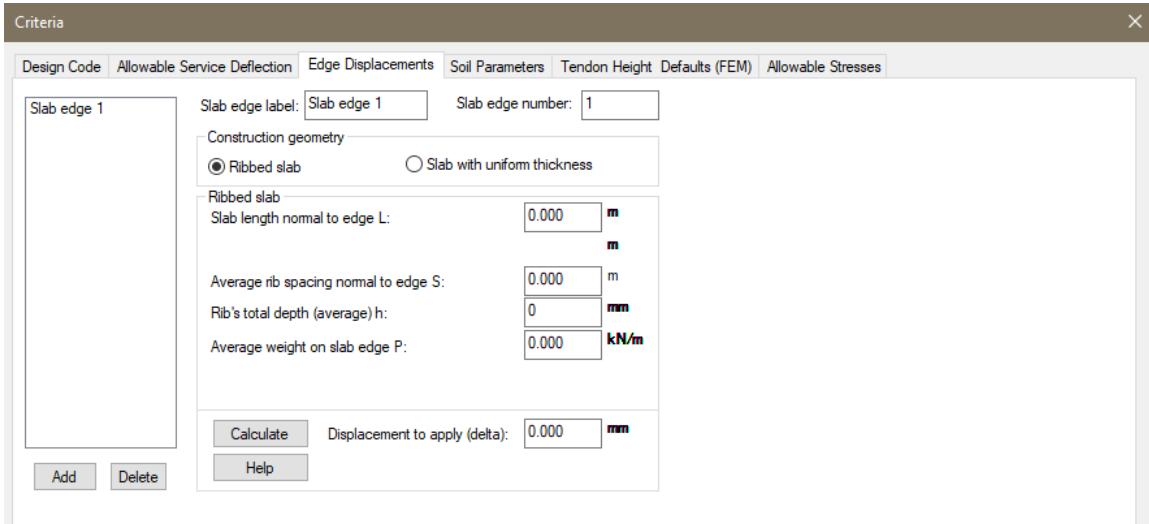

Figure 3.3-4 - Input Dialog Window for The Calculation of Applied Edge Displacement Δ for Ribbed Slabs

The factor K (Fig. 3.3-5) is used to obtain a ribbed Slab equivalent of a uniform foundation for the purpose of using the PTI deflection formula. Its background and application are given in Chapter 4.

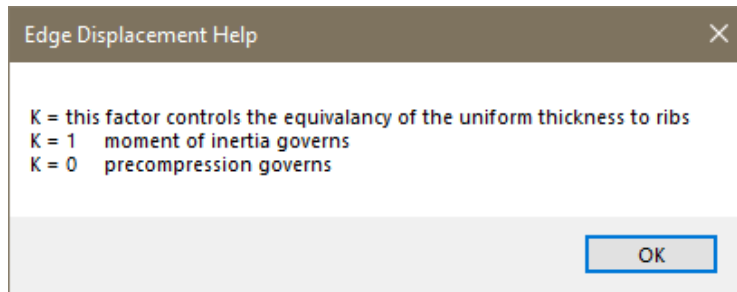

Figure 3.3-5 - Factor K for Equivalency of Uniform Thickness to Ribbed Foundation

Allowable in-service stresses are entered in the dialog window shown in Fig. 3.3-6. The program can automatically check the stresses over the entire foundation and report graphically, as well as in tabular form, the locations where the calculated stresses exceed those entered in Fig. 3.3-6. In version 1.xx of the program, the stress checks are limited to the fiber stresses due to the combined action of bending and axial forces. The shear forces for each Design Strip are reported, but the shear stresses are not calculated. Refer to the design example(s) in this manual for the code check of shear stresses.



Figure 3.3-6 - Input Dialog Window for Allowable Calculated Service Stresses

The data input for the allowable deflection ratio is illustrated in **Fig. 3.3-7**.



Figure 3.3-7 - Input Dialog Window for Allowable Deflection Ratio

3.4 Applied Load from Structure Above

The applied load on the foundation Slab has the same scope and features as in MODELER. Briefly, the load can be applied anywhere on the Slab and essentially in any shape. The load components are:

- Point load in the vertical direction; concentrated moments along the X- and/or Y-direction;
- Line load with uniform or variable intensity; moments about the X- and/or Y-direction distributed along a user-defined line; and
- Patch (area) load of uniform or variable intensity over a user-defined area.

While, for convenience in generation of input data, you are permitted to draw the location of the loading over any region, the program evaluates your input and considers loading that falls on either the Slab or Beam foundation. Loading drawn over Openings and outside the Slab boundary will be automatically disregarded by the program.

Load generation wizards assist you further in the application of loading.

3.5 Applied Displacement from the Soil

The applied displacement can only be in the vertical direction, either upward or downward. The displacement options available are:

- Point displacement and
- Line displacement.

You select the location on the Slab/Beam and specify the amount by which the foundation must be displaced in the vertical direction. In addition, you may apply loads at other locations over the Slab/Beam. The program determines the displacement of the remainder of the foundation and the stresses associated with it. Obviously, an applied displacement upward can cause a gap below a region of the Slab.

3.6 Load Combination

In both center lift and edge lift conditions, the contact area between the foundation Slab and soil is likely to change due to the application of the load. A

gap may be created, or an existing gap may reduce. As a result, all the applicable loads must be considered to act simultaneously, and the solution obtained integrally for all the load components. When the geometry or boundary condition of a structure depends on the type and magnitude of applied loading, the principle of superposition generally does not apply. In other words, selfweight, dead, live, prestressing and any other load on the structure must be solved for a combined solution. A change in the extent of soil contact with the foundation of the structure is the reason behind this restriction.

Only one loading combination is permitted for any given solution. The default set by the program is to consider all the loads you define along with post-tensioning, if any. Other modules of the BUILDER platform, where the geometry and boundary conditions of the structure remain unchanged, allow more than one load combination.

3.7 Analysis of the Structure

Once you have completed the generation of the foundation geometry and defined its material; post-tensioning; loading; allowable stress values, and soil parameters, you are ready to analyze the structure. The steps in the analysis are identical to that of FLOOR-Pro and detailed in the FLOOR-Pro Tutorial. Briefly, the steps are as follows:

- Mesh the structure;
- Analyze the structure;
- View to validate the solution;
- Create Design Strips in two orthogonal directions;
- Create and design the design sections automatically;
- View the graphical display of code check for stresses;
- Modify the design (post-tensioning), if stresses exceed the code values and repeat the analysis; otherwise
- Create a report from the successful analysis and design; and
- Export the solution as a DWG file to assist you in the completion of the structural drawings.

Go through the SOG tutorial(s) and review the exercises of the BUILDER software platform, before attempting your first project.

3.8 Creation of Design Strips and Design Check

The analysis part consists of the determination of displacements and the associated forces at the nodal points of the finite element mesh. After the analysis is completed, the program performs an adequacy check of the foundation Slab by going through the design steps. The code compliance (adequacy check) consists of the following steps.

- Identify Design Strips in each direction. If the foundation is ribbed, typically each Design Strip consists of one rib and its associated tributary

(Fig. 3.8-1). If the foundation is of uniform thickness with perimeter Beams only, select each Design Strip to contain the perimeter Beam and approximately 12ft of tributary. Break the remainder of the region between the ribs into strips of approximately 12- to 15-ft strips. The reason behind the breakdown of the foundation Slab into Design Strips is that the PTI method is based on selection of “representative” quantities for each direction of the foundation. The representative quantities, such as the bending and shear stresses generally associate with the entire width of the foundation in each direction. This might be acceptable if the foundation you design follows the assumptions of PTI method. That is to say, the foundation Slab is essentially of rectangular geometry; the distribution of ribs, if any are regular; the loading is uniform and is applied on the perimeter only. There are other limitations that are stated in the appendix. But, if the structure you design does not possess the degree of regularity inherent in PTI’s method, then you need to break the structure into multiple Design Strips, in order to obtain a more credible design. The following examples illustrate this concept.

Figure 3.8-1(a) shows a foundation Slab with a simple outline. It is one of the examples from PTI’s publication [PTI, 1996]. For the design, PTI suggests to consider representative design rectangles as identified by the two hatched regions (parts **(b)** and **(c)** of the figure). Each design rectangle is treated in isolation. Using the E-PTI, you first analyze the floor system in its entirety, thus capturing the interaction between the various features of the foundation Slab. Then, you subdivide the Slab into a more detailed design breakdown, as shown in parts **(d)** and **(e)** of the figure. This yields a more credible outcome from your design.

If the geometry of foundation plan is complex, as is the case in most structures, the breakdown of the Slab into a larger number of representative strips is more proper. **Figure 3.8-2** illustrates both the PTI’s option (parts **(a)** through **(d)** of the figure) and the E-PTI’s alternative to select Design Strips (parts **(e)** and **(f)** of the figure).

Another example for selection of Design Strips is given in **Fig. 3.8-3**. The breakdown into a larger number of strips becomes more critical, if loading on the Slab is not uniform.

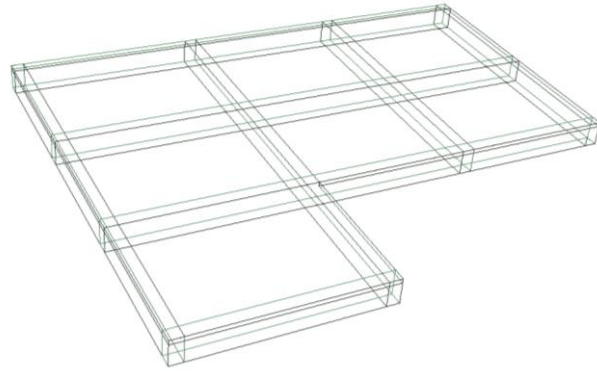

(a) 3D-View of PTI's SOG Example

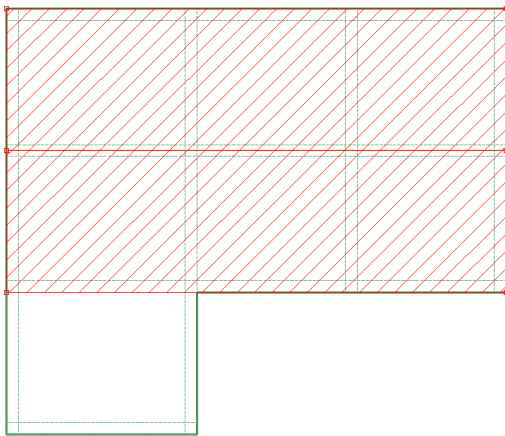

(b) PTI's Representative Rectangle in X-Direction

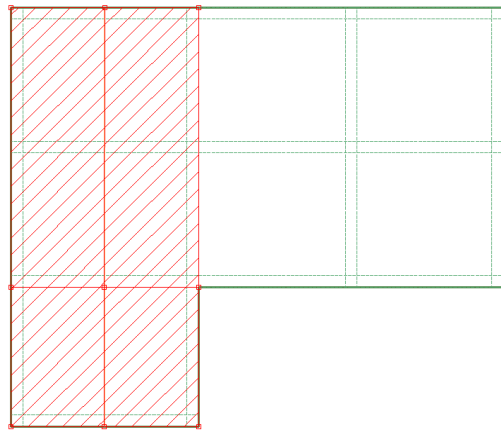

(c) PTI's Representative Rectangle in Y-Direction

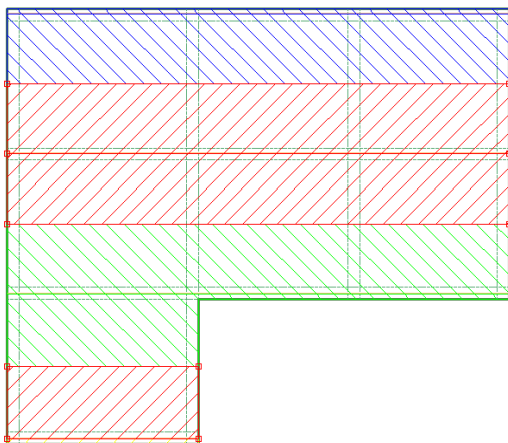

(d) Design Strips in X-Direction Using E-PTI

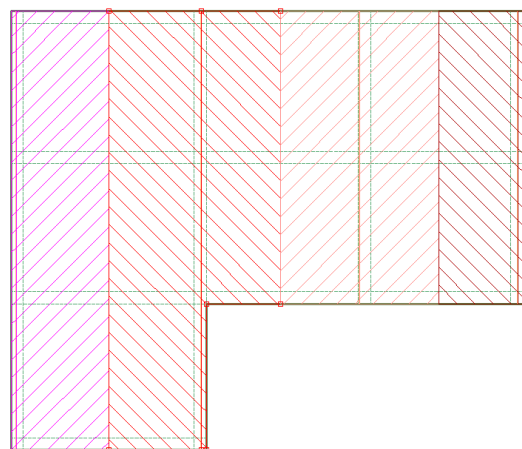

(e) Design Strips in Y-Direction Using E-PTI

Figure 3.8-1 - Design Strip Selection for a Simple Geometry

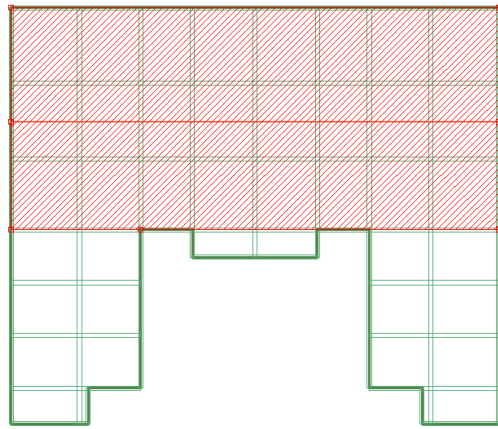

(a) Design Rectangle Along X-Direction Using PTI's Method

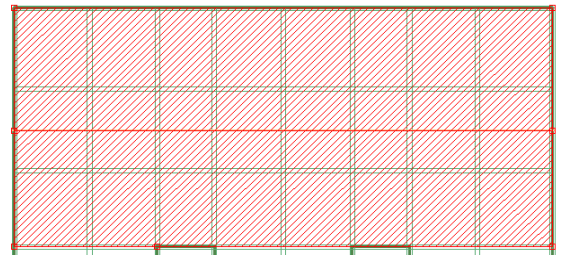

(b) Isolated Rectangle for Analysis Using PTI's Method

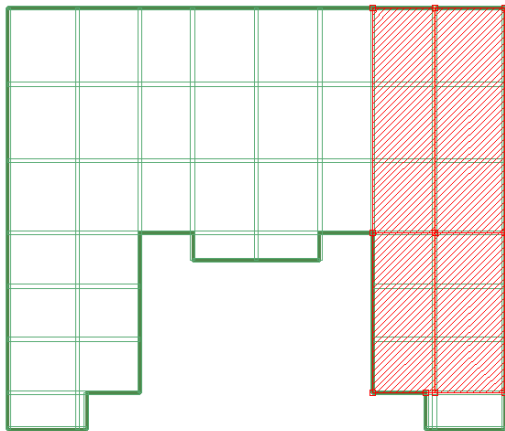

(c) Design Rectangle in the Y-Direction Using PTI's Method

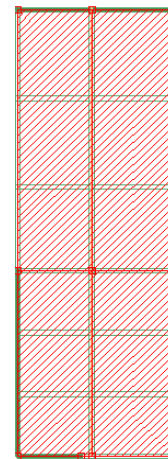

(d) Isolated Rectangle for Analysis Using PTI's Method

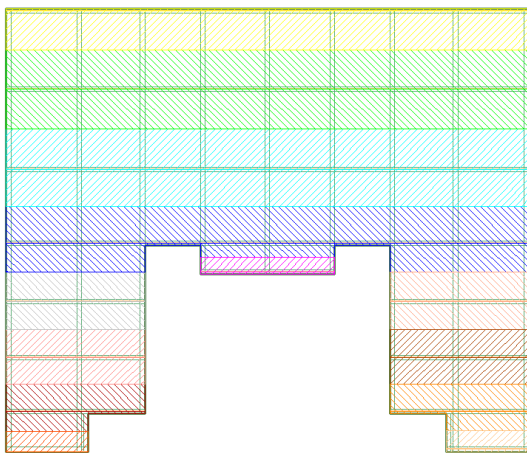

(e) Design Strips in X-Direction Using E-PTI

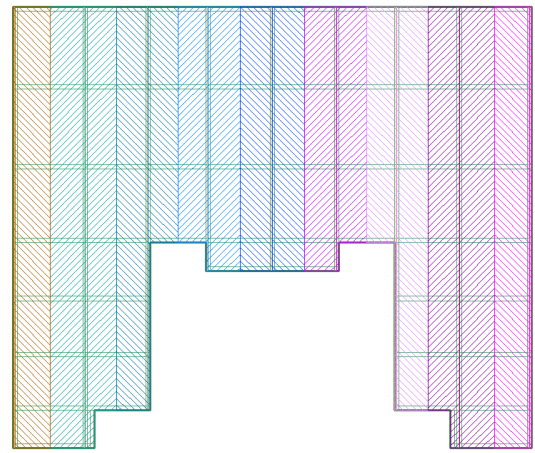

(f) Design Strips in Y-Direction Using E-PTI

Figure 3.8-2 - Example for Selection of Design Rectangles Using an Irregular Slab

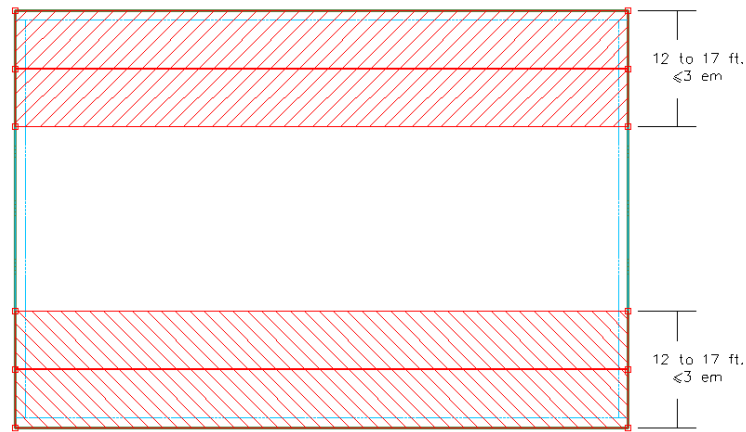

(a) Design Strips In X-Direction

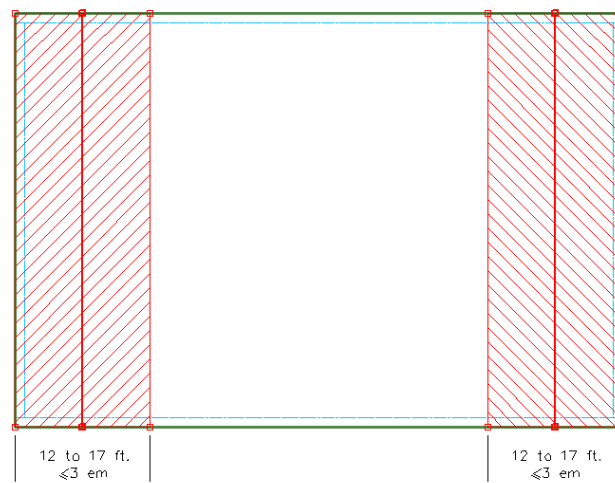

(b) Design Strips In Y-Direction

Figure 3.8-3 - Example of Design Strip Selection for a Foundation Slab of Uniform Thickness and Loading

- After the creation of Design Strips, the program automatically selects a predefined number of design sections for each of the Design Strips and performs a design check for each of the design sections. **Figure 3.8-5 (a)** shows the design sections determined by the program for Design Strip
- Each design section is drawn normal to a “Support Line” within the Design Strip. “Support Lines” are explained in detail in chapter 6 of the **ADAPT-Modeler 20 User Manual**. Briefly, and in the context of slab-on-ground, a Support Line is a line that you draw for each Design Strip to indicate the orientation of the design check. That is to say, the bending stresses within the Design Strip will be calculated in direction of the “Support Line.” The shear stresses will be for sections normal to the Support Line (design sections).

The program has a default number of subdivisions of each Design Strip into design sections, but you have the option of changing this number. In **Fig. 3.8-4**, the Design Strip is subdivided into 20 parts.

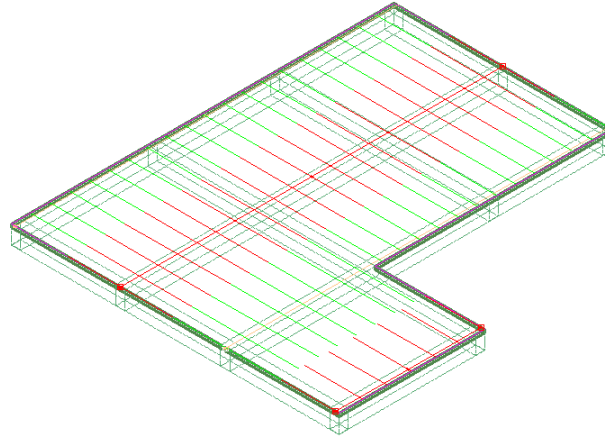

Figure 3.8-4 - Illustration of Design Sections

- After the creation of design sections, the program performs an automatic stress check. This involves calculating the bending moment, axial force and vertical shear for each of the design sections. Following the code [UBC, 1997] design procedure, these calculated actions are then applied to the cross-sectional geometry of the respective sections to determine a representative (hypothetical) bending and shear stress. The representative stresses are compared with the allowable values. If they exceed the allowable values, you must modify your design to bring the stresses within the stipulated limits. The PTI method does the same for a single representative value across the entire width of a foundation Slab.

The program displays the sections where the stresses exceed the allowable values by broken lines, or red lines if color display and printer is used. The sections, where the stresses are acceptable are shown drawn in solid green lines (if color display or printer is used). **Figure 3.8-5(a)** shows an example for bending stress check of Design Strip 2. The distribution of bending moment used or the stress check, along with the axial loading is shown in parts **(b)** and **(c)** of the figure. The vertical shear is displayed in part **(d)**.

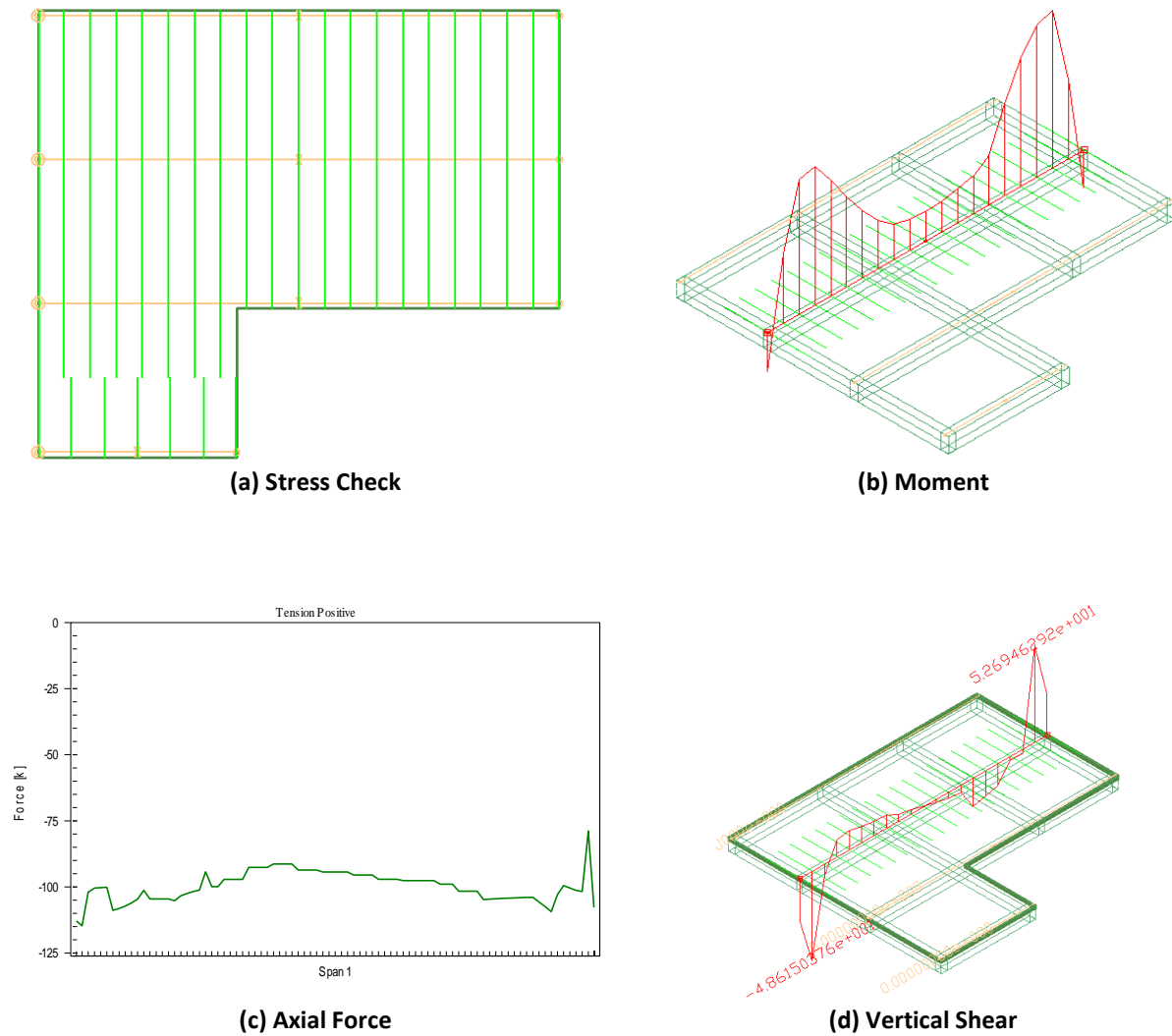

Figure 3.8-5 Example of Design Outcome for a Design Strip

3.9 Reports

The program can generate a comprehensive graphical, tabular, or mixed graphical and tabular report. The generation and types of report available are explained in other manuals of the ADAPT-BUILDER program environment. The content and length of the report generated is determined by the user. A typical report generated by the program consists of the following:

- Project details;
- Geometry of the foundation Slab;
- Specified post-tensioning;
- Soil parameters;
- Loading;
- Design criteria and values (e_m , γ_m , allowable stresses);

4 Theory and Design Procedure

4.1 Background

The background to the PTI's design procedure and its extension to the Enhanced PTI method (E-PTI) are given in **Appendix B** of this manual. While this program is well suited to design post-tensioned foundation Slabs using other criteria than the PTI's, the focus of the following is the PTI and E-PTI method.

A post-tensioned foundation slab on expansive or compressible soil is designed for two load cases, namely the "center lift" and "edge lift" conditions.

4.2 Center Lift

For center lift condition, the profile of the soil mound is assumed to be as shown in **Fig. 4.2-1(a)**, if covered by an impervious flexible membrane. For this condition, the values of e_m and y_m are provided by the soil engineer, based on the properties of the soil and the anticipated seasonal changes in the soil moisture. These soil parameters are described in detail in **Appendix B**.

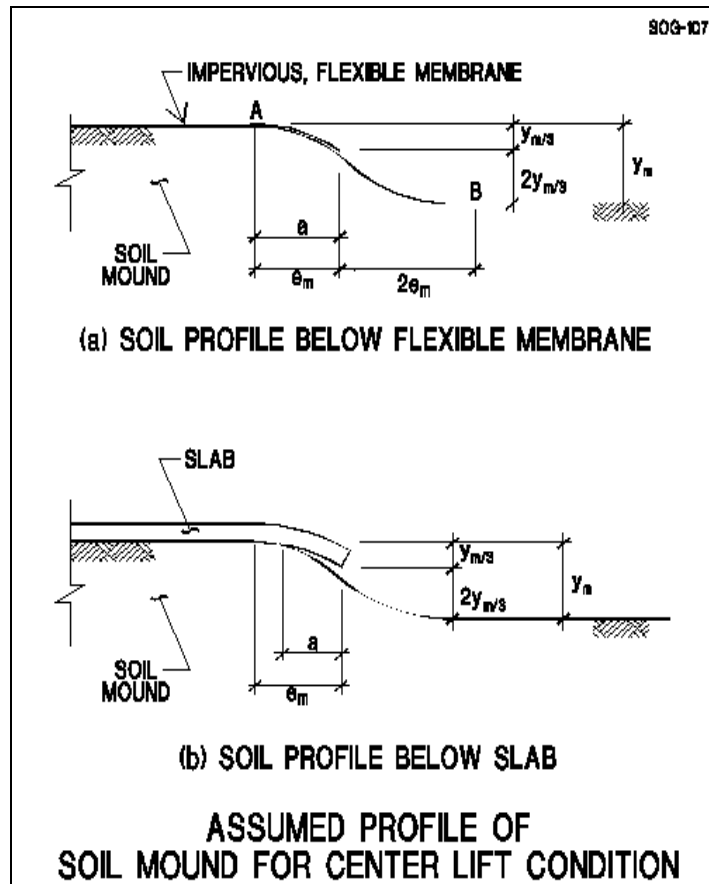

Figure 4.2-1

Foundation Slabs have a finite thickness and therefore stiffness. They do not necessarily follow the soil profile as indicated in part (a) of **Fig. 4.2-1**. In the

absence of more credible information, it is recommended to follow the design using the assumptions listed below:

- The soil profile is in form of a reversed parabola;
- The inflection point is at the tip of the Slab edge (or membrane of **Fig. 4.2-1(a)**); and
- The inflection point is at one-third of y_m .

The above assumptions can be substituted with any other reasonable shape for the profile of the soil, in order to continue with the design.

In an actual foundation Slab, three scenarios for the center lift can be identified:

- The Slab deflects, but not far enough to keep contact with the soil (**Fig. 4.2-1(b)**). In this case, the gap between the soffit of the foundation and the soil will be reduced to the distance “a”;
- The Slab deflects as much as the gap. There will be no force transfer between the Slab and soil over the distance e_m ; and;
- The Slab edge follows the soil profile and maintains compression at the interface with the soil, albeit at a lower value.

Follow the design as described below:

- Assume initially that the gap “a” is equal to e_m . It follows that in your design, you first define the soil to cover the interior of the Slab up to a distance e_m from the Slab edge;
- Obtain a solution;
- Check the deflection at the Slab edge;
 - If the calculated deflection does not exceed $(y_m/3)$, accept the solution. The design is conservative. Move to the next step for deflection check at the interior of the Slab and for stress check. The actual deflection and stresses are likely to be less.
 - If the deflection is more than $(y_m/3)$, it is likely that the Slab will not lose contact from the soil over the entire length e_m . The actual deflection will be less than given by the analysis. In this case also the design is conservative. Two conditions may arise.
 - If the stress and deflection checks from the solution obtained are satisfactory, accept the conservative solution as final;
 - If the stress and deflection checks of the solution obtained exceed the permissible values, attempt to obtain a more accurate solution. A more accurate solution may reveal that the stresses are acceptable. Otherwise, you have to modify your design. Repeat the solution by reducing the gap below the Slab edge. You do so by increasing the contact area of the soil. Repeat

the solution, until one of the two following conditions is satisfied:

- The deflection at Slab edge does not exceed $(y_m/3)$ or
- The deflection check and stress check over the Slab are satisfactory.

The flow chart of this design procedure is given in **Fig. 4.2-2**.

CENTER LIFT DESIGN Flow Chart

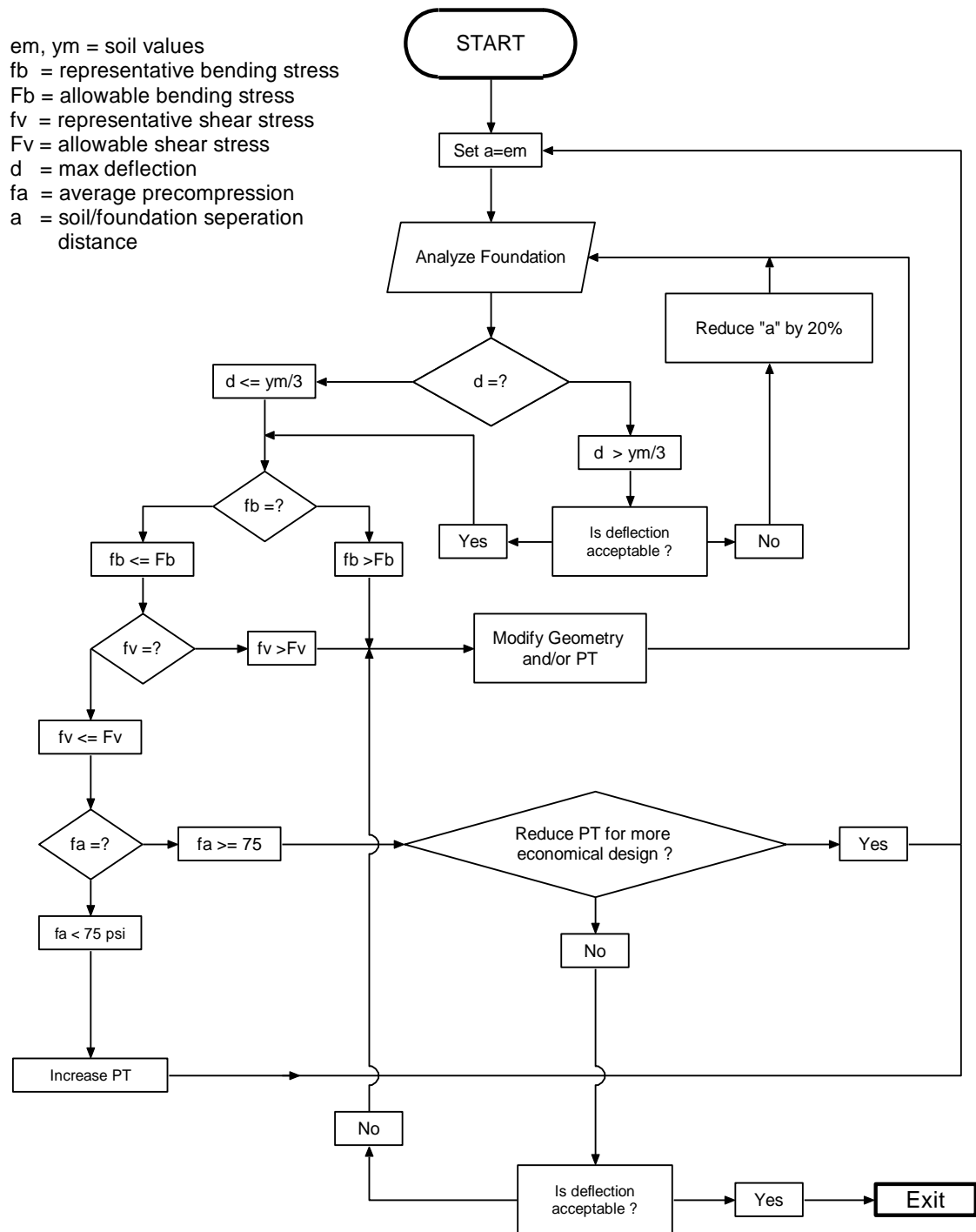

Figure 4.2-2 - Flow Chart of Center Lift Design Procedure

4.3 Edge Lift

4.3.1 Design Procedure

This loading condition is somewhat more complex. Refer to **Fig. 4.3.1-1**. The edge of the Slab is assumed to lift by an amount equal to Δ . Due to the finite stiffness of the foundation, Δ will be less than y_m . The rise at the Slab edge may lead to a gap below the Slab equal to "a." The gap "a" can exceed e_m .

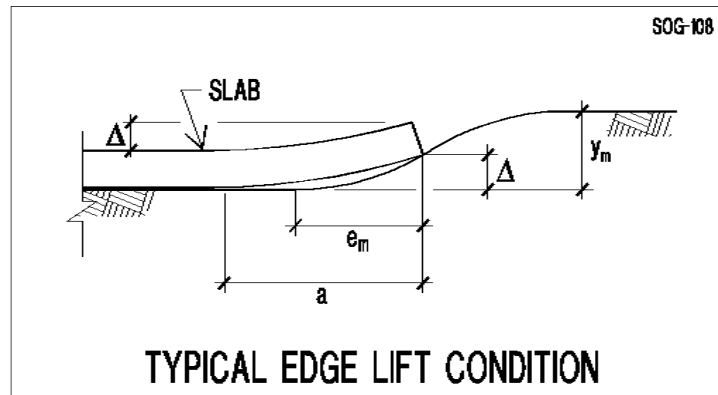

Figure 4.3.1-1

For a realistic calculation of Δ , you need to account for the interaction among the soil characteristics, moisture content of the soil, response of the soil with moisture content to externally applied stress, lapse of time, and in this case stiffness of the foundation slab and its creep properties. A central concept of the soil response is illustrated in **Fig. 4.3.1-2** in a simplified manner. In the figure y_m represents the swelling of an expansive soil sample due to increase in moisture with no loading from above. If the soil sample is subjected to a load from above, the amount of the heave depends primarily on the applied force and the moisture. In the extreme condition, if the magnitude of the applied force is high enough and the moisture is excessive, the soil will not be able to sustain the load and will give way. If lateral dilation permits, the soil expands laterally and the resulting Δ will be negative.

The interaction of soil, moisture, and the applied stress is more complex than shown in **Fig. 4.3.1-2**. The PTI formula for the calculation of Δ is a first attempt to obtain a value for design. The formula is inadequate and can lead to values grossly in error, as evidenced by the flying Slabs described in **Appendix B**. Despite its shortcomings, at the time of compilation of this manual, PTI formula seems to be the only practical alternative, besides having been quoted in the codes. For this reason, E-PTI is also based on the PTI formula when dealing with the edge lift condition with the exception that it detects the cases when the results of the formula are impractical and using engineering judgment recommends modifications.

The modified procedure is described next and illustrated in the flow chart of Fig. 4.3.1-3.

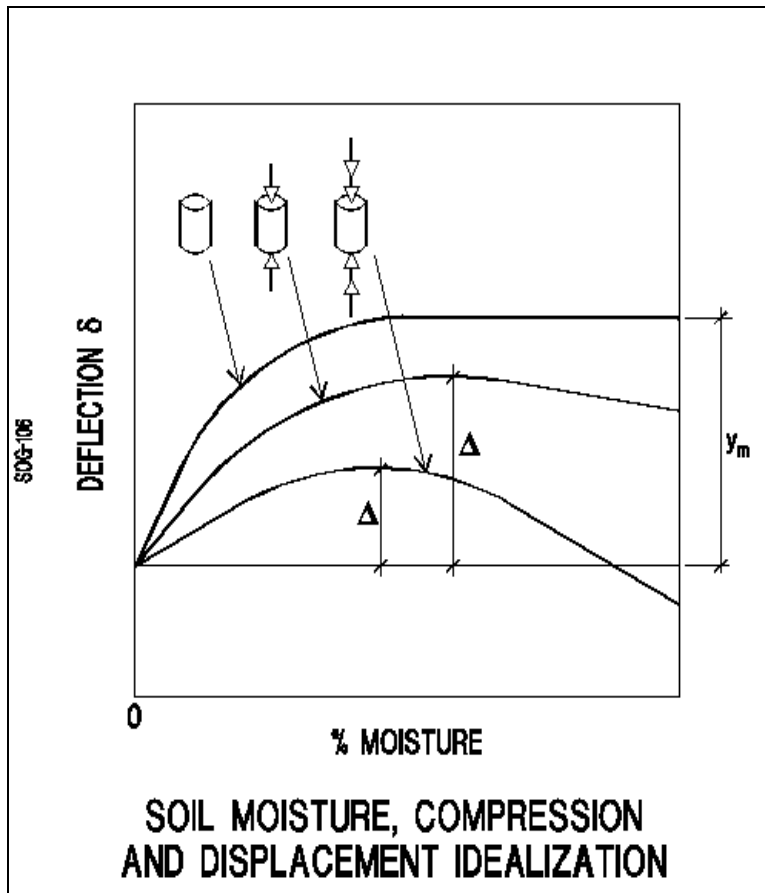

Figure 4.3.1-2

The design procedure is as follows:

- Determine the value of Δ , using the PTI method;
- Assume initially that the soil is in contact with the Slab over its entire area;
- Apply the edge displacement to the Slab. The program will automatically determine the extent of loss of contact (distance "a") using an iterative procedure;
- Perform the following checks on the solution.
 - Check the soil pressure below the Slab. If the interior of the Slab is found to have lifted off the soil entirely (flying Slab, Fig. B4.5.3-2 of Appendix B), discard the input value Δ determined by the PTI formula. In some instances, the Δ values calculated by the current PTI method are larger than the value needed to keep the Slab on the ground. The condition for flying Slabs is described in greater detail in Appendix B. It is an

inaccuracy in PTI's formula for applied displacement Δ that has to be corrected in due course.

- Engineering judgment suggests that in most practical scenarios, the gap below the Slab "a" due to the edge lift is unlikely to exceed three times the associated e_m . In the absence of a more credible criterion, if the loss of contact of Slab calculated by the program for the value of Δ is more than three times the associated e_m , discard Δ as being too high. Limit the calculated loss of contact to $3e_m$. Reduce the value of Δ and re-analyze the foundation Slab again until the loss of contact becomes approximately equal or less than $3e_m$.
- Perform deflection and stress checks, once you accept the solution.

The flow chart of the procedure explained is shown in **Fig. 4.3.1-3**.

EDGE LIFT DESIGN Flow Chart

em, ym = soil values
 fb = representative bending stress
 Fb = allowable bending stress
 fv = representative shear stress
 Fv = allowable shear stress
 d = max deflection
 fa = average precompression
 a = soil/foundation separation distance
 Delta = Edge Lift

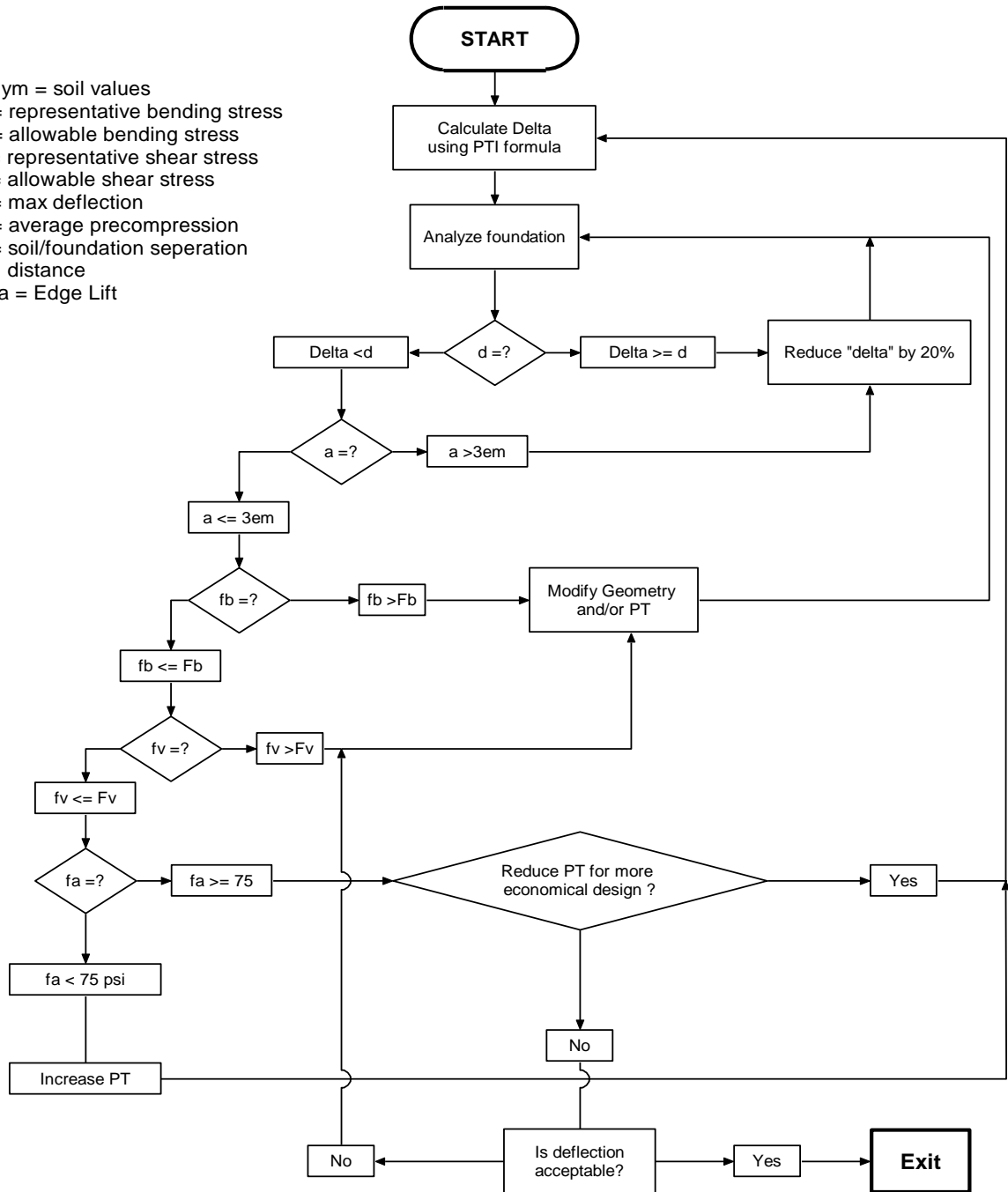

Figure 4.3.1-3 Flow Chart Of Edge Lift Design Procedure

4.3.2 Edge Lift Calculation Δ

The calculation of edge lift deflection delta follows the PTI formula reproduced below:

$$\Delta_o = \frac{(L)^{0.35} (S)^{0.88} (e_m)^{0.74} (y_m)^{0.76}}{15.9(h)^{0.85} (P)^{0.01}}$$

Where,

- L = total Slab length (or total length of the design rectangle) in the direction being considered, ft.
- S = spacing of the interior stiffening Beams, ft. If the Beam spacing varies, the average spacing may be used as long as the ratio between the largest and smallest spacing does not exceed 1.5. If the ratio between the largest and smallest spacing exceeds 1.5, use S = 0.85 times the largest spacing.
- h = depth of the stiffening Beams, measured from the top surface of the Slab to the bottom of Beam, in
- P = a uniform unfactored line load P acting along the entire Slab perimeter representing the weight of the exterior building material and the portion of the superstructure dead and live loads which frame into the exterior wall, lb/ft.

Not all foundation Slabs are made up of rectangular parts, such as the example shown in **Fig. 4.3.2-1(a)**. For calculation of delta, it is recommended to take a length (L) in direction normal to the edge being analyzed. Limit the length L to a maximum of 50ft. It is assumed that regions beyond 50ft from the foundation edge being lifted are not going to impact the region affected by the lift. Further, the upper value used in the derivation of PTI's formula for the derivation of Δ formula was 48ft.

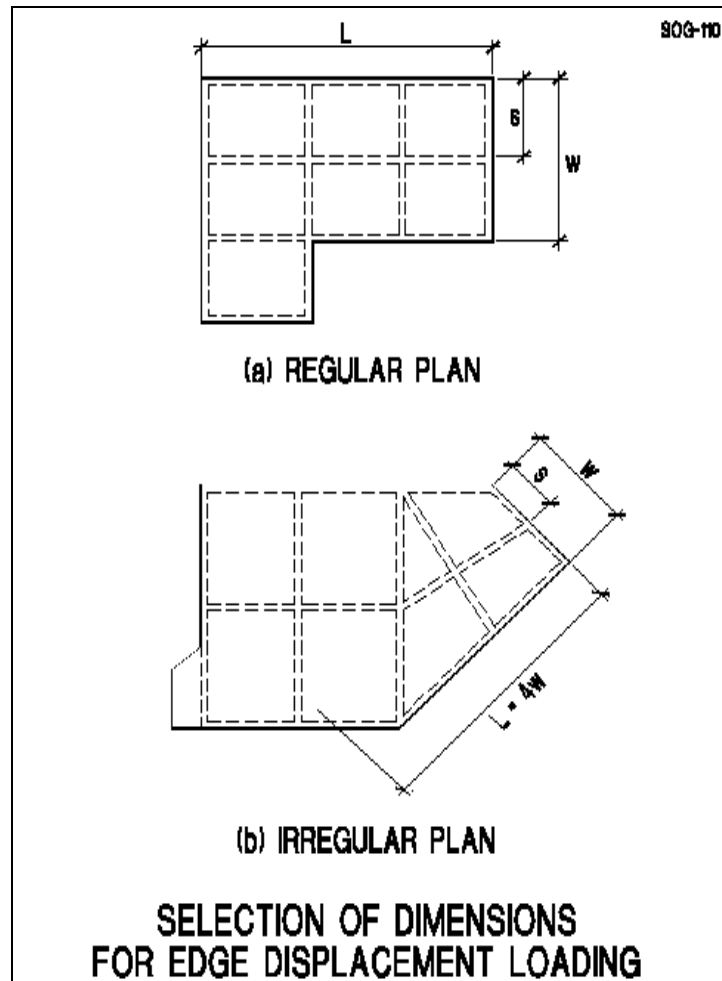

Figure 4.3.2-1

4.3.2.1 Calculation of delta for ribbed foundations

For ribbed Slabs, the geometry of the foundation can be directly input into Δ formula.

4.3.2.2 Calculation of delta for uniform Slabs

The raw data used for the development of PTI formula for Δ was developed for uniform Slabs. But, the format in which the PTI's method is presented makes it impractical to use the raw data. The procedure suggested by PTI is to convert the uniform thickness foundation to a ribbed equivalent; then, use the Δ formula. This was applied to both foundation Slabs of uniform thickness and foundation Slabs with perimeter Beams only (parts (a) and (b) of Fig. 3.1-1). PTI's deflection formula is expressed for part (c) of the figure.

The parameters of the ribbed Slab suggested by PTI for conversion are as follows:

- Beam depth 24 inch;
- Beam width 10 inch; and
- Slab thickness 3 inch.

In general, a uniform Slab cannot be converted into a ribbed Slab with the above parameters by satisfying both the equivalency in deflected shape, which is governed by the moment of inertia, and the equivalency in precompression; which is governed by the cross-sectional area. There is also the option of equivalency in flexural stresses that is not handled neither by PTI, nor ADAPT-SOG.

ADAPT-SOG includes a utility that does the conversion from uniform to ribbed Slab based on the importance you place on the accuracy in deflection calculation as opposed to the average precompression. You do so, by assigning a value between 1 and 0 to a factor K introduced in the program. If K=0, equivalency in precompression governs. That is to say, the axial stress at the centroid of the actual foundation Slab and its equivalent will be the same. If K=1, deflection governs. That is to say, the deflected value of the two foundations will be the same. Values between 0 and 1 can be used to control the importance of deflection relative to precompression.

5 Design of Post-Tensioned Slabs on Expansive Soil Using the Enhanced PTI Method

5.1 Overview

There are several ways to design a post-tensioned slab that will be constructed on expansive soil; one is the PTI method [PTI, 1996]. This report describes an enhancement to the PTI method, referred to as the Enhanced PTI (E-PTI) method and illustrates its application to the design of a typical SOG (Slab-On-Ground). The E-PTI method is a finite- element-based combination of structural modeling, analysis, and design developed for concrete structures, in particular post-tensioned concrete Slabs and Beams [Aalami, 2001]. The report concludes with comments and remarks on the PTI and E-PTI methods. A copy of the PTI's design example reviewed in this report is attached at the end of this report for quick reference.

5.2 Background

5.2.1 Scope of Application

The PTI method was developed for the design of ground supported slabs that meet the following criteria [Wray, 1978; PTI, 1996].

- The underlying soil undergoes volume changes due to changes in its moisture content.
- The structure supported by the slab consists of light construction, typically one to three levels of wood framing.
- The load on the slab from the supported structure is through the perimeter walls and is between 600 and 1,500 plf.
- The load on the interior of the slab is limited to a uniform live load of 40 psf and a uniform dead load of 65 psf (self-weight of an assumed 4 in slab plus a superimposed dead load of 15 psf).
- The soil has a modulus of elasticity of 1000 psi.

The PTI method has other limitations, some of which are discussed in **Section 5.6** of this report. In practice, however, the method is often used for conditions beyond its inherent limits.

When designing a SOG on expansive soil, the main design criteria are satisfactory performance of the slab under service load conditions. Ground supported slabs do not need to be designed for ultimate strength since slab failure due to overload is not likely to lead to injury. The slab must be able to resist and span over soil deformations, however, so that displacement of the supported structure is limited to an acceptable value. Displacement under service load conditions must be limited to avoid cracking in the supported structure and ensure that doors and windows function properly. In addition, it is generally desirable for occupants not to notice any unevenness of the slab. For a

typical wood framed structure with stucco and dry wall, the acceptable displacement is generally assumed to be 1 over 250 or 300.

The slab edge may need to cantilever over soil where there has been a loss of volume or may be deflected up due to an increase in volume of the soil. In both cases, the slab may lose contact with the soil over limited areas and may need to span over voids created by the volume change.

As shown in **Fig. 5.2-1**, there is an initial (one-time) displacement of the soil below the slab due to consolidation. This is superimposed over displacements due to seasonal variations in the moisture content of the soil. The initial consolidation usually takes place over a long period of time but at a decreasing rate. This displacement is not addressed in the PTI design method. The PTI design method only addresses the effects of the seasonal changes.

Loads from posts and interior bearing walls may affect the in-service performance of the slab. Such loads are not accounted for in the PTI design method. These loads are typically handled by the design engineer through “structural detailing”. The structural detailing may include addition of nonprestressed reinforcement, thickened slab sections, stiffening Beams or adjustments to the Tendon layout.

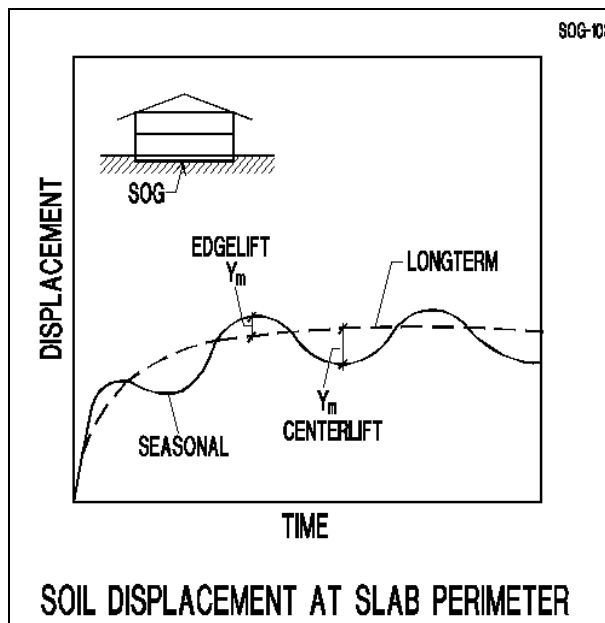

Figure 5.2-1

This report discusses new developments in computational technology and design tools that allow the PTI method to be extended beyond its inherent limits. After a brief summary of the PTI method, application of the E-PTI method is illustrated by working one of the PTI’s SOG design examples. The report concludes with a discussion of the merits and shortcomings of the new method. The new method is a major

improvement over the PTI method, but does not yet cover all the complexities of SOG design. More work is needed and is in progress.

5.2.2 Soil Response to Variations in the Moisture Content

Figure 5.2-2 illustrates the basis of the PTI design method. Under steady state conditions, a homogeneous mass of expansive soil on level ground will have a uniform moisture content as illustrated by the hatched area in the lower half of **Fig. 5.2-2(a)**.

Changes in the moisture content will lead to the uniform rise or fall of the top surface (the datum line in the figure).

When a flexible (zero stiffness), impervious membrane is placed over part of the soil mass, subsequent moisture changes result in two conditions (parts b and c of the figure).

- (i) Loss of moisture in the soil outside the membrane results in a variation in moisture content as shown in part b of the figure and a drop in the ground level as the soil contracts. In this case, referred to as the **Center Lift** condition:
- The maximum drop in the ground level outside the membrane is y_m .
 - The drop of the ground level at the perimeter of the membrane is less than y_m .
 - Since the membrane has no stiffness, it follows the displaced surface of the soil. There is no gap between the membrane and soil surface.
 - The moisture content varies over a distance e_m inward from the boundaries of the membrane. This is referred to as the edge penetration distance.
 - There is no vertical displacement at the interior of the membrane, where the moisture content has not changed.

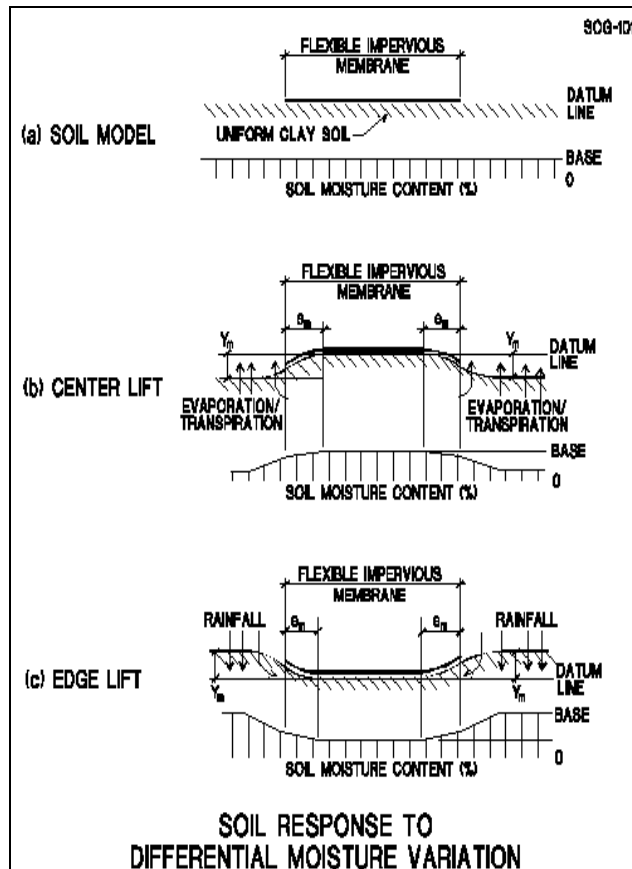

Figure 5.2-2

(ii) An increase in moisture of the soil outside the membrane leads to a rise in the ground level. In this case, referred to as **Edge Lift** condition:

- The maximum rise in the ground level outside the membrane is y_m .
- The rise in the ground level at the perimeter of the membrane is less than y_m .
- Since the membrane has no stiffness, it follows the displaced surface of the soil. There is no gap between the membrane and soil surface.
- The moisture content varies over a distance e_m inward from the boundaries of the membrane.
- There is no vertical displacement at the interior of the membrane, where the moisture content has not changed.

5.2.3 Response of the Slab to Variations in the Moisture Content of the Soil

Since a slab has a finite stiffness, it will not necessarily follow the changes in the underlying soil (**Fig. 5.2-3**).

5.2.3.1 Center lift condition

In a center lift condition, the slab is likely to cantilever over the distance marked “a” in the **Fig. 5.2-3**. The distance “a” is less

than e_m since the edge load, along with the weight of the overhang, will cause the slab to deflect slightly for a short distance from the point where the ground level starts to drop. The maximum differential displacement in the slab, Δ , is generally from the edge of the slab to its center, where the soil pressure is least disturbed.

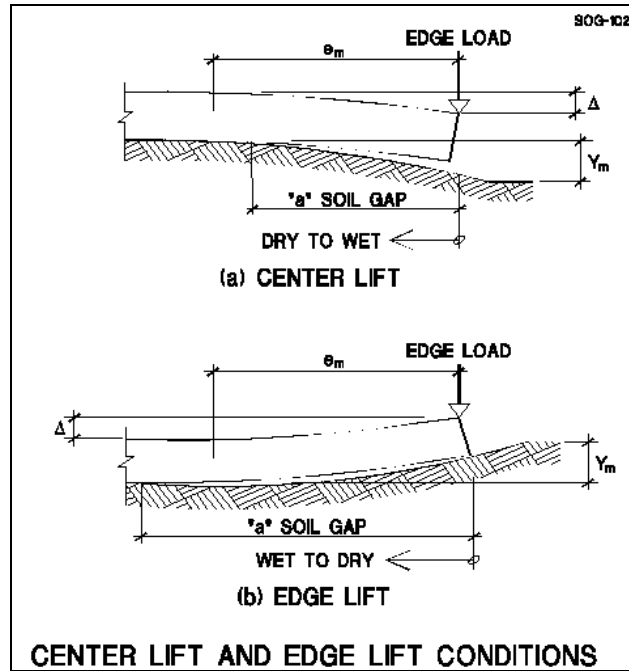

CENTER LIFT AND EDGE LIFT CONDITIONS

Figure 5.2-3 - Center Lift and Edge Lift Conditions

5.2.3.2 Edge lift condition

Again, due to the stiffness of the slab, the slab displacement is likely to be different from that of the underlying soil. A gap may form below the slab over the distance marked “a” around the slab perimeter. The displacement of the slab edge, Δ , depends on the magnitude of the applied edge load, the stiffness of the slab, and the properties of the underlying soil, including its moisture content. The force transfer between the slab and the soil around the perimeter is essentially along the slab edge, however. With a higher edge load, there will be less uplift. It is possible that an extremely high edge load would cause the slab to deflect downwards. The forces developed in the slab are a function of the edge displacement, Δ .

5.3 PTI Design Method

The following are the steps of the PTI design method:

- Set the soil parameters. This is generally done by a geotechnical engineer. The parameters are as follows:

- Center lift
 - y_m
 - e_m
- Edge lift
 - y_m
 - e_m
- Select the concrete strength, f'_c (specified strength at 28 days)
- Specify the design criteria
- Allowable values for calculated concrete stresses
 - Allowable Tensile Stress:
 - $f_t = 6 * f'_c{}^{0.5}$
 - Allowable Compressive Stress:
 - $f_c = 0.45 * f'_c$
 - Allowable Shear Stress
 - $v_c = 1.7 * f'_c{}^{0.5} + 0.2f_p$
 - where f_p is the average precompression
 - Maximum differential displacement (relative deflection) of the top of the slab:
 - 1/300 over any length
- Determine the cross-sectional geometry of the slab.
 - There are two commonly used geometries – a slab of uniform thickness or a ribbed slab.
- Select the post-tensioning
 - Assume the layout and number of post-tensioning Tendons in the two principal directions.
- Determine the loading
 - The externally applied load from the supported structure is limited to the perimeter of the slab. The distribution of the load around the perimeter is assumed to be uniform and constant.

- Dead load is assumed to be 65 psf (50 psf self-weight of the concrete slab and 15 psf superimposed dead load).
 - In addition to the perimeter load, a uniform live load of 40 psf is assumed.
 - No other loads may be specified.
- Design
 - Assume the slab to be made up of rectangular regions, overlapped if necessary, that cover the entire slab area.
 - Treat each of the rectangular regions separately, subject to the perimeter load and the y_m/e_m parameters.
 - Using the formulas given in PTI method, determine the design values. These are “representative” tension, compression and shear stresses for each of the rectangles.
 - Compare the “representative” stresses with the allowable values. If the allowable values are exceeded, make adjustments as necessary.

5.4 Enhanced PTI (E-PTI) Method

The E-PTI method accounts for some of the features of a SOG that are not adequately addressed in the PTI method. This leads to an improvement in both slab performance and economy. The following are the principal improvements:

- The approximations inherent in PTI’s method of modeling the cross-sectional geometry of the slab and the loading are reduced, hence the design (representative) stresses are closer to actual stresses. The design can more closely match the allowable stress limits.
- By designing the entire slab in one run and including both the plan and elevation irregularities, the method identifies regions of higher stresses, where the design engineer needs to provide special detailing to avoid excessive cracking. Likewise, areas with less stress, which require less prestressing are also identified.
- By recognizing the shape of the Tendon paths in both the vertical and horizontal planes, the advantages of Tendon profiling in ribbed Slabs can be reflected in the design.
- Posts loads and loads from the interior walls can be automatically accounted for. No additional design effort is required for their detailing.
- Using the electronic (DWG) files of the architectural plans of the building, or by using a drawing created by the engineer, the design is one step closer to the automated generation of structural drawings. This reduces the design time, and more importantly eliminates errors that can occur when transferring information from one set of calculations to the next and onto the drawings.

5.4.1 Analysis Tool

The E-PTI method is based on a finite element procedure specifically developed for the analysis and design of concrete structures, in particular post-tensioned concrete floors, Slabs and Beams [Aalami, 2001]. The Component Technology concept is used to represent the features of the slab, the post-tensioning, the supports and the loading. Beams, steps, Openings and other Slab features are modeled with their true dimensions and elevations which is central to the valid determination of stresses in post-tensioned slabs. Tendons are represented as finite elements, using the integrated technology discussed in the reference as opposed to the traditional “load balancing” method. This allows the effects of variations in force along a Tendon due to losses, including friction due to curvature and wobble in both the horizontal and vertical planes, to be accounted for. The design values are based on the integration of nodal actions, which makes them less sensitive to the density of the mesh [CI, Dec.,2001]. Finally, instead of using the entire width of a Slab as in the original PTI method, tributary areas are used to arrive at design stresses (representative values) for each Design Strip [Aalami, Kelley, 2001a]. This results in a closer correlation between the design and the anticipated Slab performance.

5.4.2 Soil Parameters and Modeling

The Enhanced PTI method uses the same design parameters as the original PTI method, namely:

- Soil parameters
 - Center lift
 - y_m
 - e_m
 - Edge lift
 - y_m
 - e_m

The soil is modeled as a Winkler foundation and is represented by a series of closely spaced elastic springs that are only capable of developing compression. Tension between the soil and the structure is not allowed - the structure is allowed to lift off the soil and form a gap, where needed.

For a center lift condition, the Slab is initially assumed to be in contact with the soil to the point where the edge moisture variation (e_m) begins. The loss of contact between the soil and the structure, shown as the distance “a” in **Fig. 5.2-3(a)** is likely to be less than e_m . The initial assumption of a gap equal to e_m is conservative.

The calculated deflection, Δ , is compared with y_m , the differential soil movement, to determine whether the assumed length of the gap between the Slab and the underlying soil is valid. The calculated deflection cannot exceed y_m ; if the calculated deflection exceeds y_m , the distance “a” over which there is a soil separation, is reduced until the deflection Δ is less than or equal to y_m . In most cases, the calculated Δ is less than y_m and no iteration is necessary. Strictly speaking, Δ should be less than y_m (**Fig. 5.2-3**). A limit for Δ not to exceed one third of y_m might be more valid, but in this report conservatively $\Delta_{max} = y_m$ is used.

For the edge lift condition, the gap between the Slab and the soil is initially assumed to be equal to the edge moisture penetration distance, e_m . The actual extent of the gap is determined by an iterative procedure, based on the elimination of tension between the Slab and soil. The actions (moment, shear and axial force) in the Slab are governed by the deflected shape of the Slab. The analysis assumes that the Slab is lifted through a distance, Δ , along its perimeter (**Fig. 5.2-3 (b)**). The displacement Δ depends on the properties of the soil, the stiffness of the Slab, and the edge load. It cannot be determined just from the properties of the Slab and the loading. The properties of the soil and its moisture content are critical to the determination of edge displacement. In its current state of development, the E-PTI method is limited to the treatment of the structural aspects of the soil-structure interaction. Work is underway to add the soil component to the analysis for the determination of the edge lift at the Slab perimeter. In the absence of a more rigorous analysis, and until the soil parameters are integrated into the Enhanced PTI method, the formula for the relative deflection, Δ , suggested in the PTI Method is used. The formula is:

$$\Delta_o = \frac{(L)^{0.35} (S)^{0.88} (e_m)^{0.74} (y_m)^{0.76}}{15.9(h)^{0.85} (P)^{0.01}}$$

Where,

- L = total Slab length (or total length of the design rectangle) in the direction being considered, ft.
- S = spacing of the interior stiffening Beams, ft. If the Beam spacing varies, the average spacing may be used as long as the ratio between the largest and smallest spacing does not exceed 1.5. If the ratio between the largest and smallest spacing exceeds 1.5, use S = 0.85 times the largest spacing.
- h = depth of the stiffening Beams, measured from the top surface of the Slab to the bottom of Beam, in.

P = a uniform unfactored line load P acting along the entire Slab perimeter representing the weight of the exterior building material and the portion of the superstructure dead and live loads which frame into the exterior wall, lb/ft.

The value of Δ is calculated for both the long and short directions of the Slab or design rectangle using the above equation. In some cases, the calculated displacement using the PTI method is greater than that needed to lift the entire building off the ground (float the Slab). This unrealistic condition is described in greater detail later in this report.

If the Slab is to have a uniform thickness, PTI method suggests designing a ribbed Slab for moment, shear, and differential deflection, and then converting the cross-section to a uniform thickness using the following conversion equation:

$$H = \sqrt[3]{\frac{I}{W}}$$

H = thickness of a uniform thickness Slab, in.
 I = gross concrete moment of inertia, in⁴.
 W = foundation width in the direction being considered, perpendicular to L, ft.

5.4.3 Analysis

The analysis determines the displacement, the actions (moment, shear, and axial load), average precompression, and top and bottom stresses for the entire Slab. The analysis values, when displayed graphically, provide a clear presentation of the Slab response and are an essential means of validating the solution and locating areas of the Slab where special detailing may be required. The analysis results give an overview of the response of the Slab and values of displacement and actions at each "point." The analysis results, however, are not used for design, however. Using a procedure based on tributary areas and Design Strips, the analysis values are integrated to provide a set of "design values" as described next.

5.4.4 Determination of Design Values

The determination of design values is similar to the PTI procedure of converting the analysis results into "representative values" for design. In the PTI method, a formula is used to calculate one representative design value for the entire Slab width. The E-PTI method differs in that it uses finite element analysis to determine several "design values" for each side of a Slab, one for each of the Design Strips. This allows variations in Slab features to be accounted for and is believed to provide a more appropriate design.

A detailed account of processing general-purpose finite element analysis results to determine “design values” in concrete structures is given in [Aalami, Kelley 2000]. The design values are applied to the cross-sectional geometry of each Design Strip, to determine the adequacy of the design.

Briefly, the steps are as follows:

- Identify Support Lines in each direction (if the Slab is ribbed, the Support Lines would be the centerlines of the Beams).
- Assign a tributary area to each Support Line. Each Support Line and its tributary area form a Design Strip.
- Select design sections along each Design Strip. Design sections are typically selected at the face of Beams transverse to the Design Strip, at midspans, and at a number of intermediate points within each span. A design section is normal to the Support Line (ribs in the Slab, if available).
- For each design section, determine the applicable design values (demand values of moment, shear, and axial force). The design values are determined from the finite element solution by integrating the values at the nodes across each design section. The design values are then transferred to the centroid of respective design sections.
- Determine the number, location and orientation of existing Tendons crossing each design section.
- Apply the design values of each design section to the cross-sectional geometry and prestressing of the respective design section to arrive at design stresses “representative stresses.” Compare the representative stresses with the allowable values to determine the adequacy of design.

5.4.5 Comparison of Design Values with Allowable Values

The design values (representative values) are compared with the allowable values to determine whether the design is acceptable. If the design values exceed the allowable limits, the design is modified.

The recommended deflection ratios (vertical displacement over horizontal distance Δ/L) from PTI recommendations and another reference are listed in Tables 5.4-1 and 5.4-2. PTI gives two recommended values, one for center lift and another for edge lift. If the consequence of relative deflection be possibility of malfunction and cracking in structure above the foundation slab, the logic behind having two different recommended values is not apparent.

Engineering judgment should be exercised when using the deflection ratios listed in the tables. For dimensions and loading commonly used in construction of foundation slabs, it seems impractical to satisfy deflection ratios smaller than 1/360 for both the center- and edge lifts.

Table 5.4-1 - Recommended Deflection Ratios [PTI, 1996]

Material	Center Lift	Edge Lift
Wood Frame	1/240	1/480
Stucco and Plaster	1/360	1/720
Brick Veneer	1/480	1/960
Concrete Masonry Units	1/960	1/1920
Prefab Roof Trusses*	1/1000	1/2000

*Trusses which clear span the full length or width of the foundation from edge to edge.

Table 5.4-2 - Recommended Deflection Ratios [Wray, 1978]

TYPE OF CONSTRUCTION	MAXIMUM PERMISSABLE DEFLECTION RATIO (Δ/L)
Wood Frame	1/200
Non-Masonry, Timber or Pre-Fabricated	1/200
Unplastered Masonry or Gypsum Wallboard	1/300
Non-Masonry, Frame & Panel	1/300
Stucco or Plaster	1/360
Brick Veneer (Articulated)	1/300
Brick Veneer	1/480
Brick Veneer (Standard)	1/500
Masonry (Completely Articulated)	1/500
Masonry (Partially Articulated)	1/800
Masonry, solid or cavity wall	1/1500-1/2000

5.5 Illustrative Design Example

The following example illustrates the design of a residential Slab on expansive soil. It is the example in **Appendix A.7** of reference [PTI, 1996]. The PTI design example is organized as follows:

- Geometry
- Post-tensioning
- Material
- Loading
- Design
 - Design Requirements
 - Center Lift Design
 - Edge Lift Design
 - Comments

5.5.1 Geometry

The structure consists of a 4 in Slab with 12 in wide by 24 in deep perimeter and interior Beams. **Figure 5.5-1** is a plan view of the Slab generated by the analysis and design software [ADAPT-SOG, 2002]. A more detailed plan of the Slab is shown in **Fig. 5.5-2**.

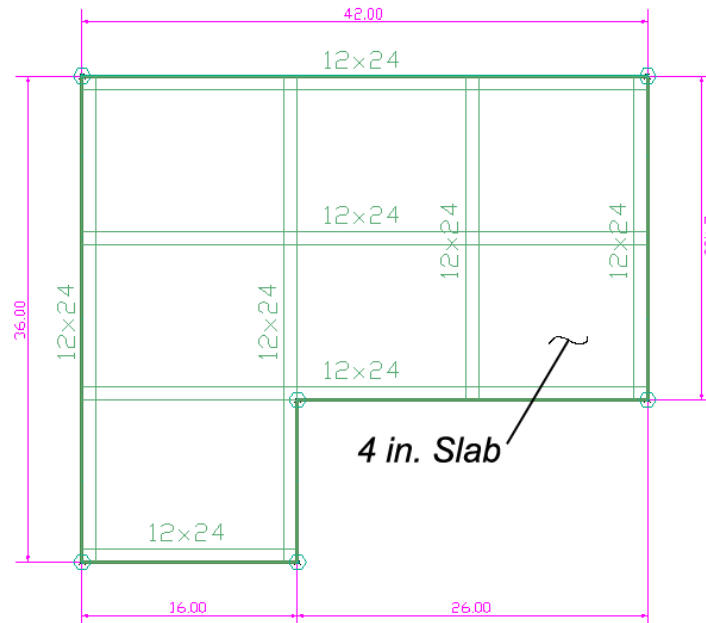
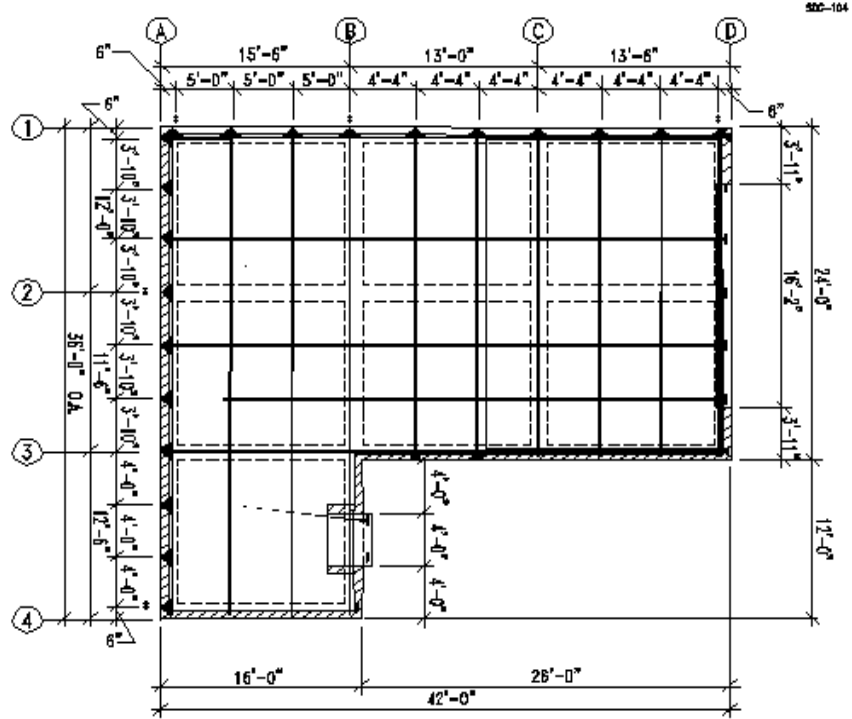

Figure 5.5-1 - Plan of Slab Used for Design

5.5.2 Post-Tensioning

The Slab is reinforced with unbonded single strand (mono-strand) post-tensioning Tendons. There are eight Tendons in the longitudinal direction and thirteen Tendons in the transverse direction (**Fig. 5.5-3**). The Tendons are flat (no profile) and are located at the mid-depth of the Slab, 2 in down from the top of Slab. The beam Tendons are draped and are located 3.25 in from the bottom of the Beams; both the beam Tendons and the slab Tendons are eccentric with respect to the centroid of the ribbed Slab. The average precompression is 114 psi. The profile of beam Tendons is shown in **Fig. 5.5-4**.



LEGEND
 ▲ STRESSING END
 — DEAD END
 * DENOTES TWO TENDONS, ONE STRAIGHT TENDON IN SLAB AND ONE PROFILE TENDON IN BEAM

PLAN

PTI's SOG DESIGN EXAMPLE A.7

Figure 5.5-2

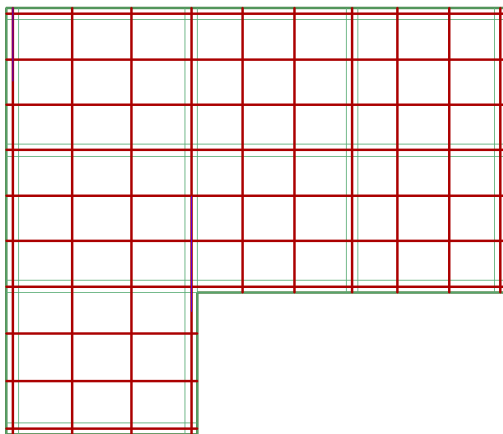

(a) Layout of Tendons in Plan



(B) 3D View of Tendon Layout

Figure 5.5-3 - Tendon Layout

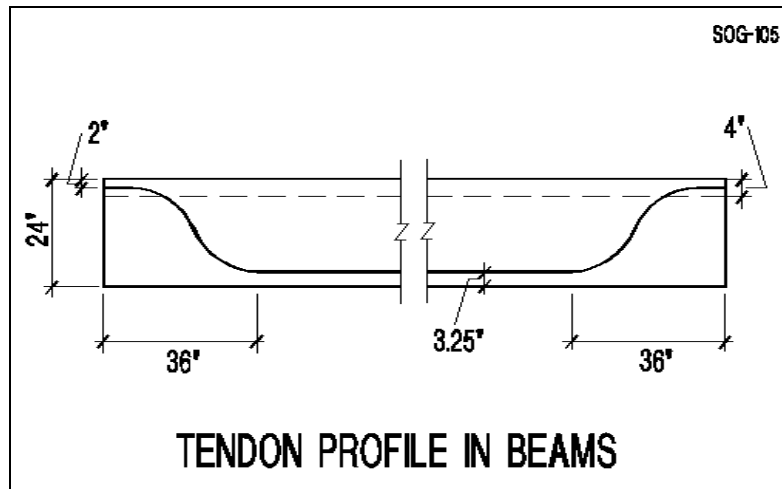

Figure 5.5-4

Other parameters of the post-tensioning are:

- 0.5-in diameter seven-wire, low-relaxation ASTM A416 strand; strand area = 0.153 in^2 ; $f_{pu} = 270 \text{ ksi}$ and
- Effective stress after all losses 175 ksi; effective force per Tendon 26.7 k.

Friction, seating loss, and other stress loss factors are accounted for by using an effective force after all losses.

5.5.3 Material

- Concrete strength: 28-day cylinder $f'_c = 2500$ psi;
- Creep Modulus of Elasticity $E_c = 1500$ ksi and
- Soil is represented with Winkler springs that can resist compression only. The spring stiffness assumed is 74 pci. This corresponds closely to 1000 psi modulus of elasticity inherent in PTI methods formulas [Bowles, 1988].

5.5.4 Loading

- Self-weight based on the Slab and Beam = 150 pcf
- Geometry using = 40 psf
- Interior uniform live load = 40 psf
- Perimeter line load = 1040 lb/ft

A graphical view of the loading specified is shown in **Fig. 5.5-5**.

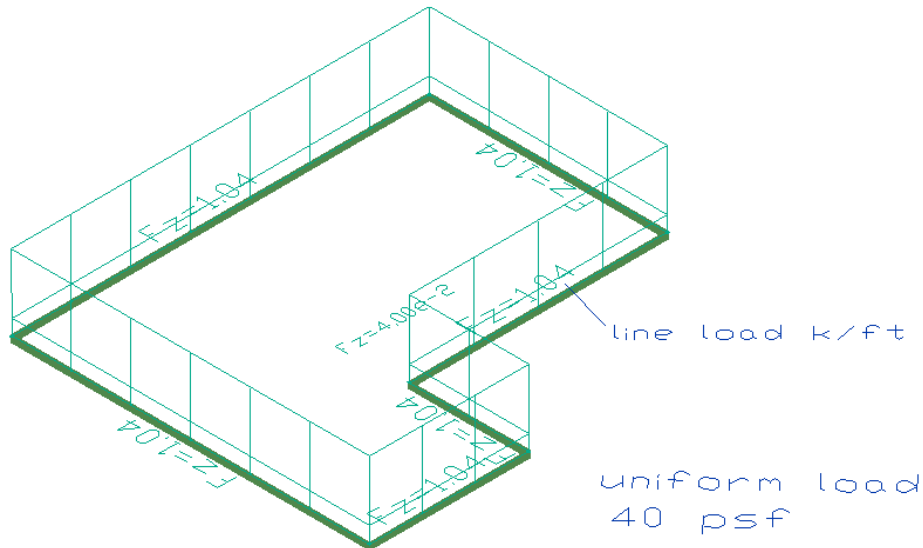

Figure 5.5-5 - View of Specified Loading

5.5.5 Design

5.5.5.1 Design Requirements

- Soil parameters
 - Center lift
 - $y_m = 0.9$ in
 - $e_m = 4.5$ ft
 - Edge lift
 - $y_m = 0.706$ in
 - $e_m = 5.5$ ft

- Allowable stress values
 - Allowable tensile stress

$$f_t = 6 * f'_c^{0.5}$$

$$= 6 * 2500^{0.5}$$

$$= 300 \text{ psi}$$
 - Allowable compressive stress

$$f_c = 0.45 * f'_c$$

$$= 0.45 * 2500$$

$$= 1125 \text{ psi}$$
 - Allowable concrete shear stress

$$v_c = 1.7 * f'_c^{0.5} + 0.2f_p$$

where f_p is the average precompression (1141 psi)

$$v_c = 1.7 * 2500^{0.5} + 0.2 * 114$$

$$= 96 \text{ psi}$$
 - Maximum deflection:
 - 1/300 over any length of Slab

5.5.5.2 Center Lift Design

5.5.5.2.1 Deflection check

Figure 5.5-6 shows the plan of the Slab with the soil separation distance $a = 3.5$ ft marked along its perimeter. The initial assumption for the soil separation distance was $a = e_m = 4.5$ ft, but the deflection at the Slab boundary obtained from this initial assumption exceeded y_m . The distance of the gap was reduced until the deflection at the edge was less than y_m (**Fig. 5.5.7** and **Fig. 5.5.-8**).

Max deflection 0.86 in < $y_m = 0.9$ in OK

1 Cross-sectional area through the slab parallel to grid line C is 1872 in². There are 8 strands normal to the section each with 26.7 k. $f_p = (8*26.7)/1872 = 114$ psi.

2 Strictly speaking, the gap should be further reduced to give the differential deflection Δ given by PTI formula. But, the design with a deflection at Slab edge less than y_m was accepted as a conservative and adequate option. E-PTI method has the option of reducing the gap until a user-defined limit in deflection is reduced.

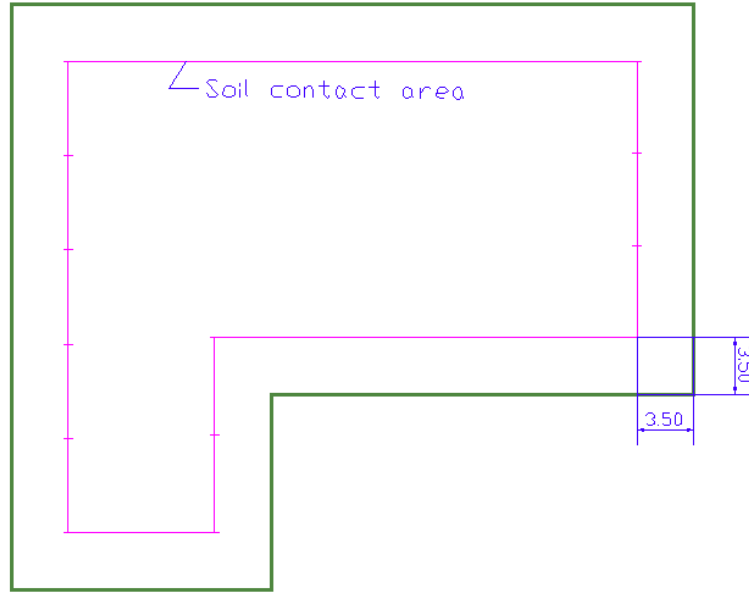

Figure 5.5-6 - Plan of Slab Showing "A" = 3.5 Ft; For Center Lift Condition

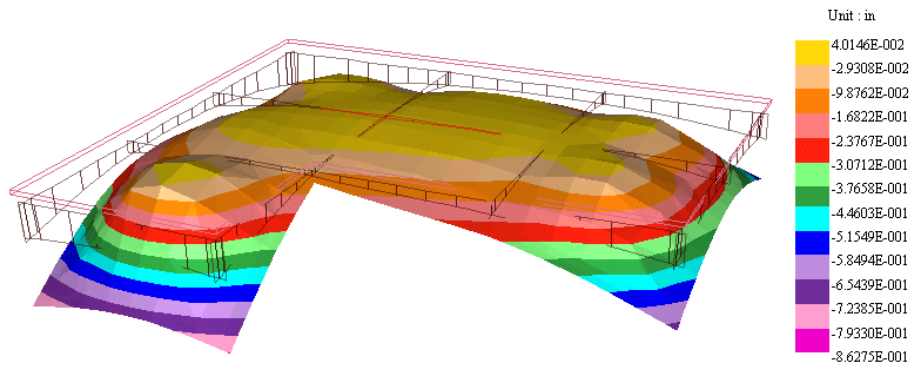

Figure 5.5-7 - Three-Dimensional View of Slab Deflection for Center Lift Condition at "A" = 3.5'

The maximum relative deflection (Δ) occurs between a point at the top left corner of the Slab and a point in the interior about 8 ft from the corner.

$$\text{Deflection ratio} = (\text{vertical}/\text{horizontal}) = 0.863/(8*12) = 1/111 > 1/300$$

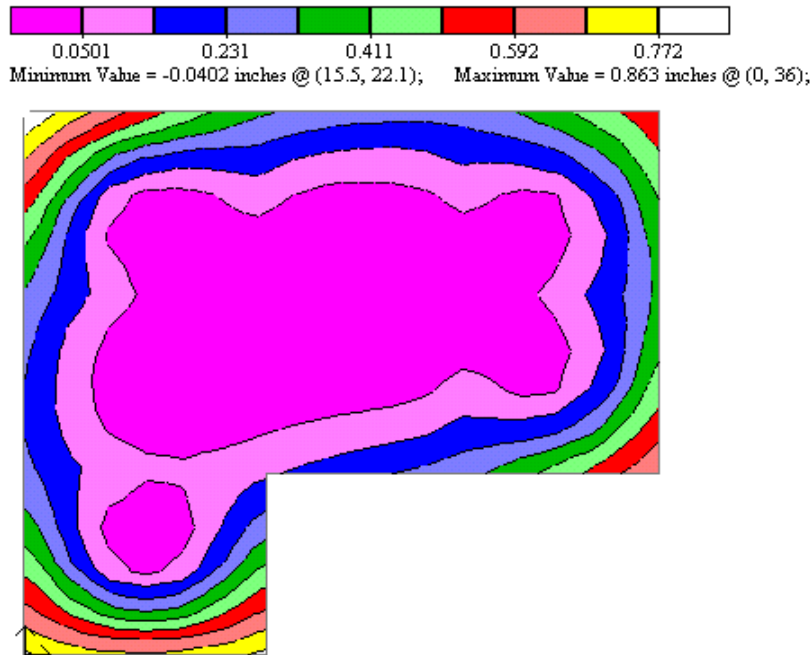

Figure 5.5-8 - Deflection Contour of Slab for Center Lift Condition

5.5.5.2.2 Stress check due to bending

The tributary areas associated with each of the Beams in the X-direction are shown in **Fig. 5.5-9(a)**. This problem uses 21 design sections so each Design Strip is subdivided into 20 equal divisions. The design values are calculated at each design section as indicated in **Fig. 5.5-10**. The “design stress” is determined by applying the calculated moment for each design section, to the geometry of the section, along with the axial loading at that section. If the calculated design stress is within allowable limits, the design section is displayed in green, otherwise it is marked with a dashed red line.

There is a positive moment at the edge of the Slab. The positive moment is primarily due to the eccentricity of Tendon at the Slab edge. Tendons anchored at Slab mid-depth are eccentric with respect to the centroid of the ribbed construction. The moment at the Slab edge is not reflected in the PTI design method results.

Figure 5.5 -9(b) shows all the Design Strips of the X-direction in green, indicating that the stresses do not exceed allowable values.

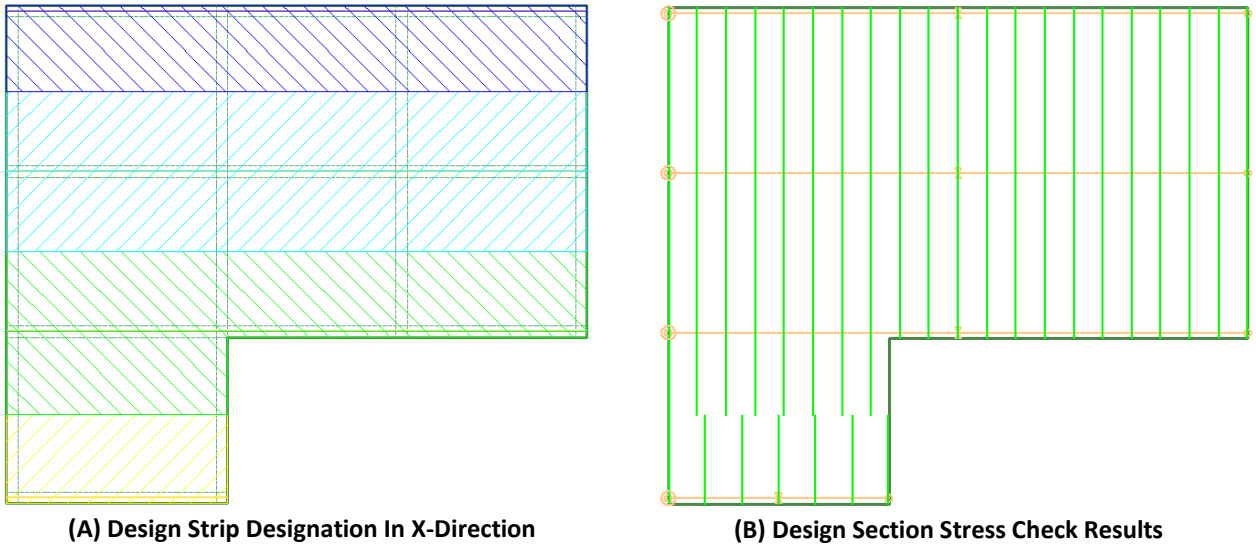

Figure 5.5-9 - Design Strips and Stress Check Results in the X-Direction for Center Lift Condition

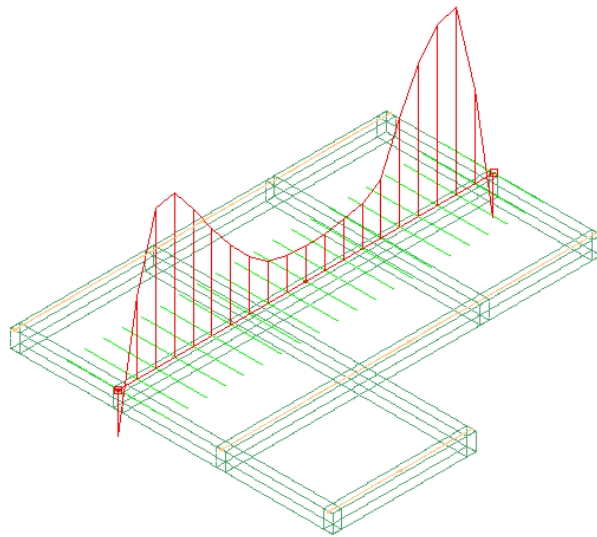

Figure 5.5-10 - Design Strip And Bending Moment At Line 2

(The green lines are the design sections at which the plotted moment distribution is calculated.)

The distribution of “design stress” for gridline 2 (Support Line 3) is shown in Fig. 5.5-11. Maximum tensile and compressive stresses are 154 and 963 psi respectively, which are both within allowable limits. The corresponding values from the PTI example [PTI, 1966] are top and bottom compressive stresses equal to 90 and 534 psi, respectively.

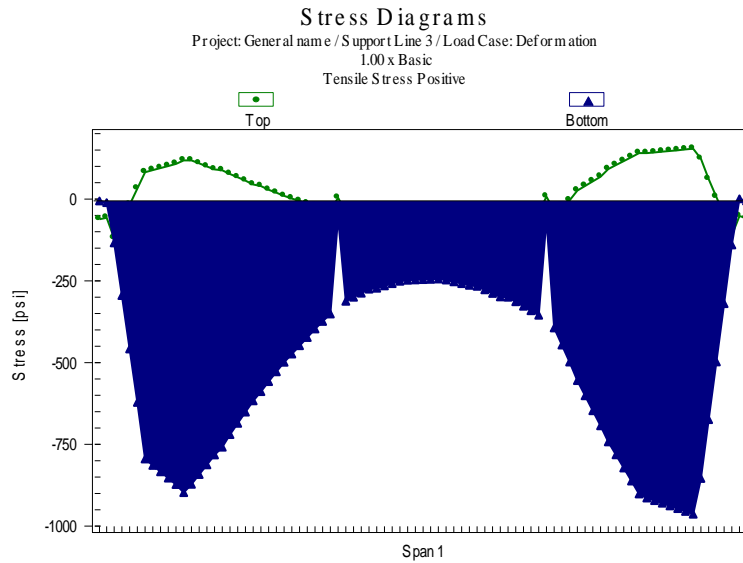

Figure 5.5-11 - Top and Bottom Fiber Design Stresses at Gridline 2

(Maximum tensile stress 154 psi < 300 psi OK; max compressive stress 963 psi < 1125 psi, OK; the sharp localized drop in stress is for the design sections that fall over the transverse Beams. They include the enlarged Beam section.)

5.5.5.2.3 Stress check due to shear

The distribution of moment and shear for the Beams is shown graphically in **Fig. 5.5-12**. However, for the purposes of design, the moment and shear in the Design Strip are used.

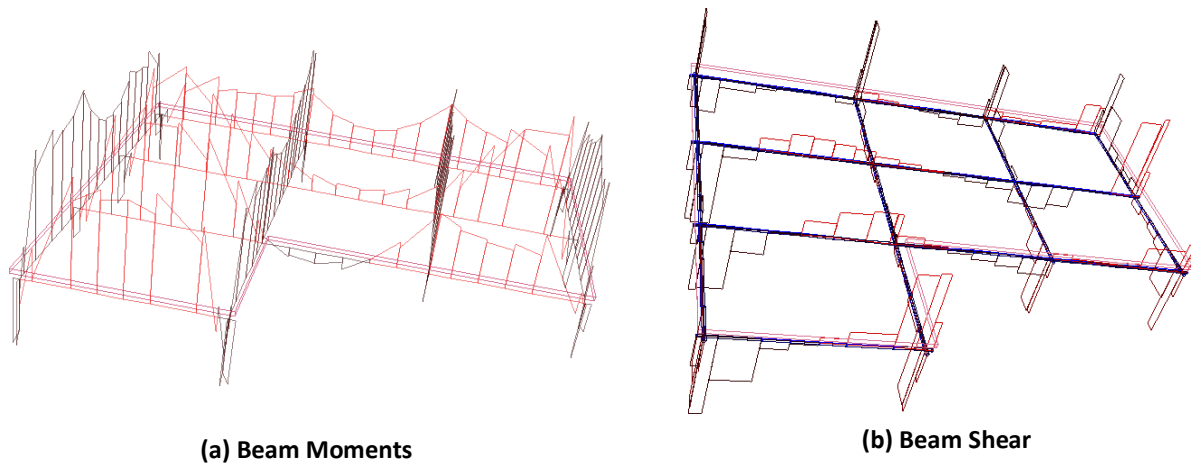

Figure 5.5-11 Distribution of Moment and Shear in the Beams

The Design Strip shear force is the sum of the shear force S due to dead and live loading, and that of the profiled prestressing Tendons. **Figure 5.5-12(a)** shows the distribution of design shear for the

Design Strip at gridline 2. The maximum shear is 52.7 k. Part (b) of the figure shows the contribution of the profiled Tendons to the design shear force. Note that in this load case (center lift) the two profiled Tendons in the Beam increase the design shear by 22 k. **Figure 5.5-4** shows the suggested detail [PTI, 1966] for the profiled Tendons in these Beams. The PTI method does not account for the adverse impact of this force.

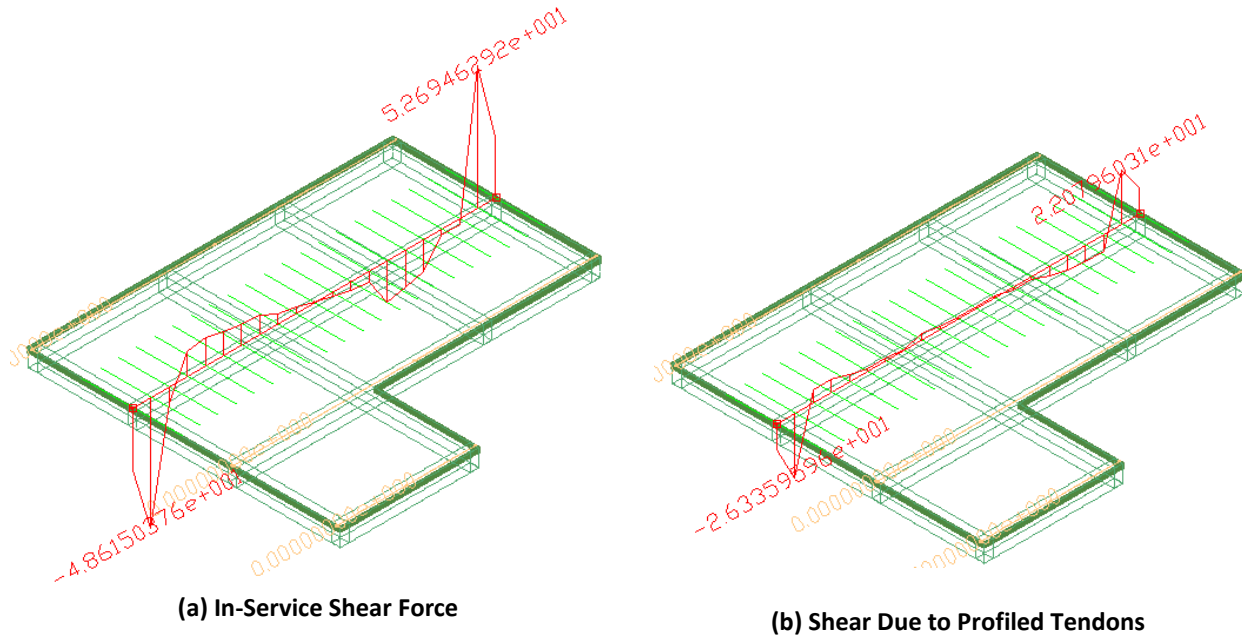

Figure 5.5-12 - Distribution of Shear at Gridline 2

The design shear stress is:

$$V = 52700 / (12 \cdot 24) = 182 \text{ psi} > 114 \text{ psi allowable shear}$$

Based on the observation of the Slabs constructed using the PTI method, the fact that the design shear exceeds the allowable value does not necessarily imply an unsatisfactory performance of the Slab. In both instances of straight and profiled Tendons the PTI method would yield the same design shear stress based on $(52.7 - 22.0) = 30.7 \text{ k}$ for gridline 2, whereas the allowance for tendon profile will increase the design shear to 52.7 k. In the PTI method the entire design shear is assumed to be resisted by the stem of the Beam. Under service conditions, the Slab also contributes in resisting the shear of the Design Strip. In the Design Strip under consideration, the contribution of the Slab to the

total shear was computed to be over 25%. The above observation also implies that there is a substantial conservatism in the PTI method in design of Slabs with straight Tendons when subject to center lift. Because of its in-built level of conservatism, the high value of the calculated design shear does not invalidate the PTI method. In the E-PTI method, the contribution of the profiled Tendons to moment and shear are allowed for. This is considered an essential inclusion in an improved design, since one of the merits of post-tensioning is the ability to profile a Tendon to suit the design objectives.

5.5.5.2.4 Soil pressure

The distribution of soil pressure below the deflected Slab is shown in **Fig. 5.5-13**. There is no soil pressure around the perimeter of the Slab over the distance “a” =3.5 ft. The maximum calculated pressure is 38.8 psi at a point near a Slab corner. The maximum pressure at the point translates to 5.6 ksf. It is reiterated that in the design of concrete structures, particularly the soil and foundation interface, the computed values at a “point” have little design significance. Variations in local conditions, geometry, and material properties dramatically influence the actual values. The distributions give a sense of overall pattern for behavior of the structure. The design should be based on integrated values over reasonable tributary areas (Design Strips). Equilibrium must be satisfied and maintained, however. The gap around the perimeter and the region of zero soil pressure is clearly observed in the three-dimensional view of **Fig. 5.5-14**.

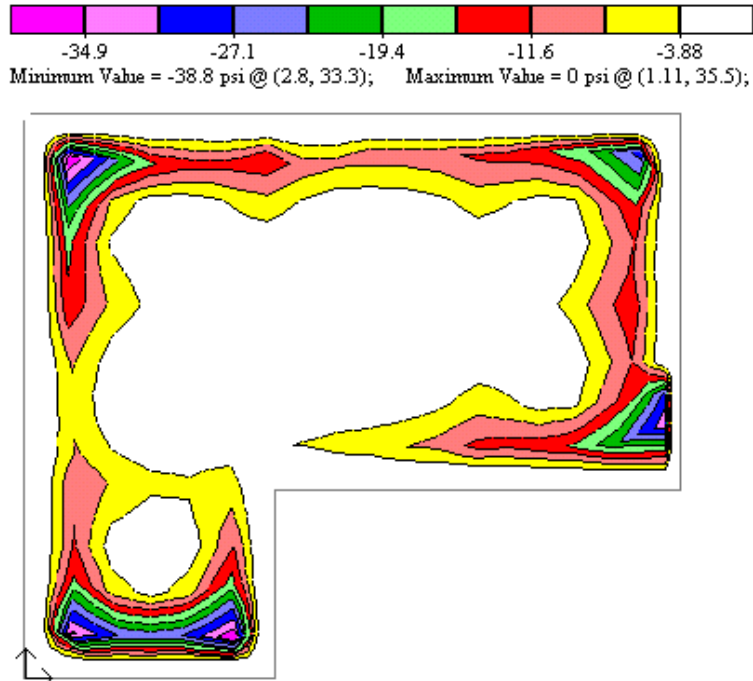

Figure 5.5-13 - Distribution of Soil Pressure for Center Lift Condition

(Maximum pressure occurs near the corners. There is uplift at some interior locations)

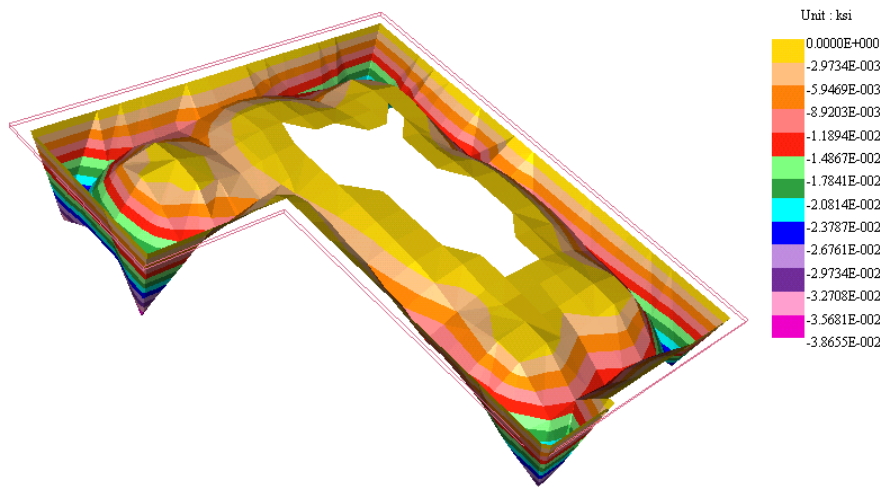

Figure 5.5-14 - Distribution of Soil Pressure

5.5.5.2.5 Equilibrium check

The total applied loading in the vertical direction should equal the integral of the soil pressure over the contact area. This check is performed automatically by the software used. The outcome is as follows.

Total downward force = 351.4 k

Integral of soil pressure over contact area = 351.4 k

5.5.5.2.6 Edge Lift Design

For the edge lift condition, the E-PTI method subjects the Slab edges to the differential displacement (Δ) calculated by the PTI method, but the value needed to lift the Slab off the ground is used as an upper limit.

Prior to attempting to obtain a solution, the specified design parameters e_m and y_m for the edge lift condition should be validated. The validation determines whether the deformation (Δ) given by PTI method's formula for "differential deflection" is at all feasible. It is based on two premises. First, the PTI method's formula for differential deflection (Δ) gives the maximum relative displacement between the edge of the Slab and a point at the interior of the Slab (see **Fig. B4.2** of [PTI, 1996]). Second, when the perimeter of a concrete slab resting freely on soil is lifted, there is a maximum relative deflection that the slab can sustain before it lifts off the ground. This is explained in more detail in **Section 5** of this report.

Consider a typical Design Strip of the Slab shown with hatched lines in **Fig. 5.5-15**. It is 13 ft wide, and has a 12 in wide by 24 in deep Beam. The Slab is 4 in thick. The properties of the Design Strip are:

Area	= 864 in ²
Moment of inertia I	= 33790 in ⁴
Span L	= 24 ft
Creep modulus E_c	= 1500 ksi
Concrete weight	= 150 pcf
Live load	= 40 psf

If the ends of the Design Strip are lifted (**Fig. 5.6-6(b)**), the deflection d will be given by:

$$d = \frac{5WL^4}{384E_cI}$$

Substituting values gives $d = 0.27$ in, which means the Slab will lift off the ground if its edges are lifted more than 0.27 in. The PTI method formula gives a maximum relative displacement of 0.307 in between the Slab edge and its interior (page 73, **Section C** of [PTI, 1996] appended to this report). Hence, the Slab floats.

Figure 5.5-15(b) shows the Slab off the soil when subjected to an edge displacement of 0.307 in. In the figure shown, the maximum differential displacement of the Slab is 0.15 in. That is to say, on account of the two-way action not reflected in the strip deflection worked out above, and the profile in post-tensioned Tendons, an edge displacement of 0.15 in is adequate to lift the Slab. A principal reason for this apparent low value of edge displacement is that, in the PTI method the entire load of the structure above is considered to act along the perimeter, where the edge displacement is applied. Further, the specified load on the Slab is very small. The Tendons at the bottom of the Beams have a relatively large eccentricity with respect to the centroid of the entire cross-section. This results in a substantial hogging moment, lowering the value of edge displacement necessary for uplift.

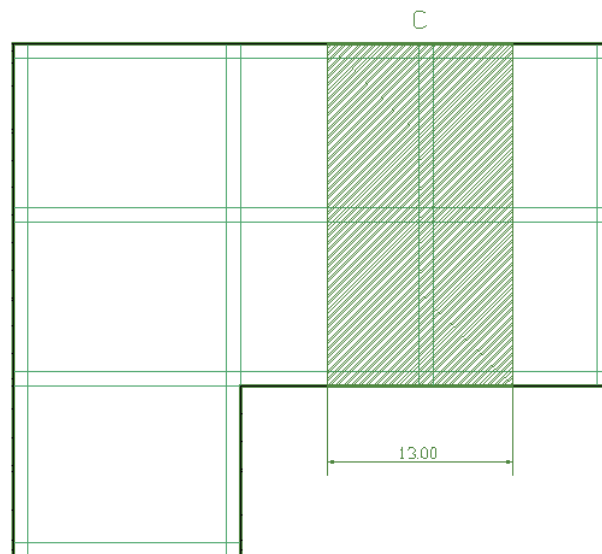
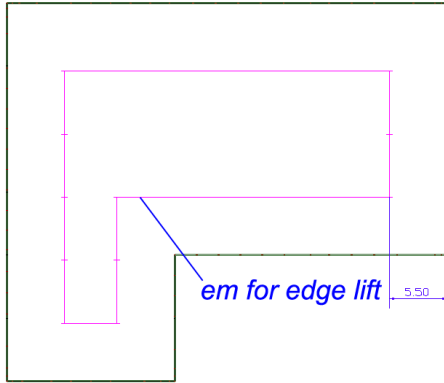
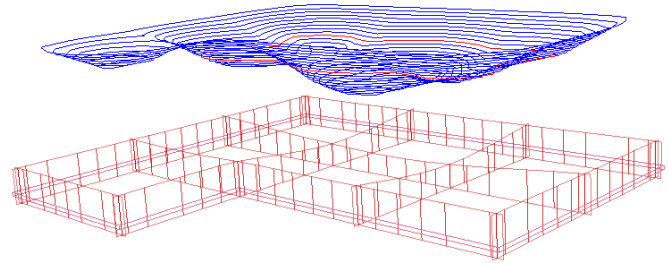

Figure 5.5-14 - Plan of Slab Showing the Design Strip at Gridline C



(a) Plan Showing E_m For Edge Lift Condition



(b) 3D View Of Floating Slab Under Specified Edge Displacement

Figure 5.5-15 - Hypothetical Floating of Slab Under Specified Differential Displacement

In the E-PTI method, if float condition occurs (part (a) of Fig. 5.5-15), the solution is discarded. A new solution is obtained by restricting the gap at the slab perimeter to approximately $e_m = 5.5$ ft. The gap is either increased or decreased until an equilibrium of forces is achieved. For the current condition, the Slab loses contact with the soil as indicated in part (b) of the figure.

Figure 5.5-15 shows very clearly that under the applied displacement, the slab is lifted from its foundation. The edge displacement is reduced to obtain an acceptable solution at uplift around the perimeter limited to about $e_m = 5.5$ ft. (Fig. 5.5-16).

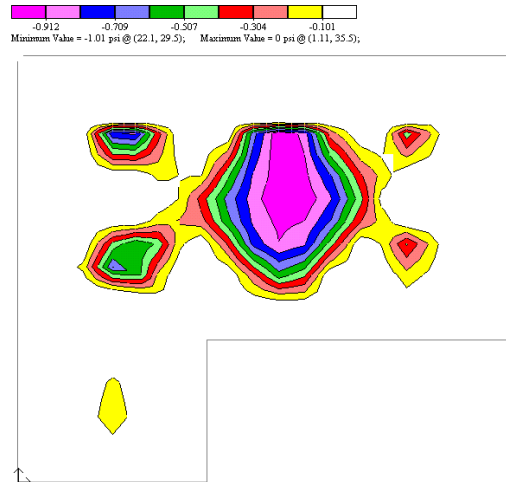

Figure 5.5-16 - Distribution of Soil Pressure for Edge Lift Equal to 0.05"

(Colorless areas indicate loss of contact with soil; the distribution of soil pressure clearly shows that the Slab lifts along the stiffening Beams)

Other design values are summarized in Figs. 5.5-16 through 5.5-19. For the edge displacement

assumed, the design values meet the allowable limits.

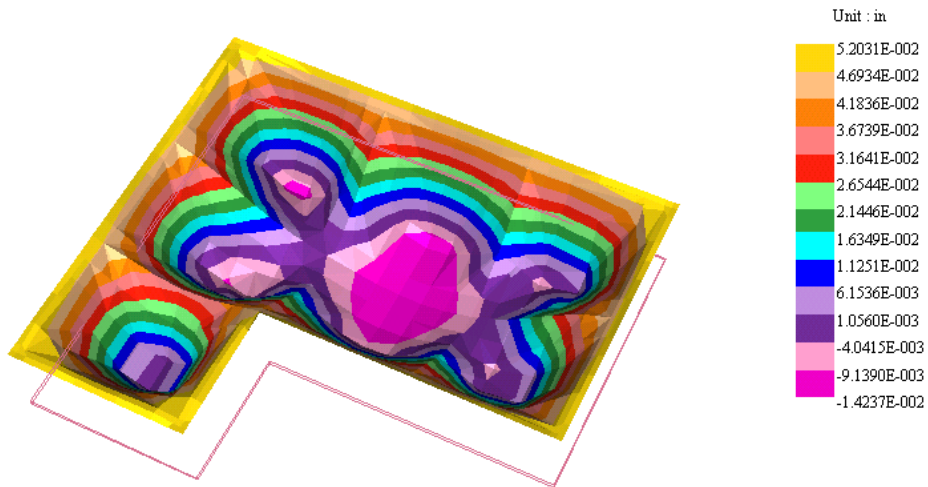
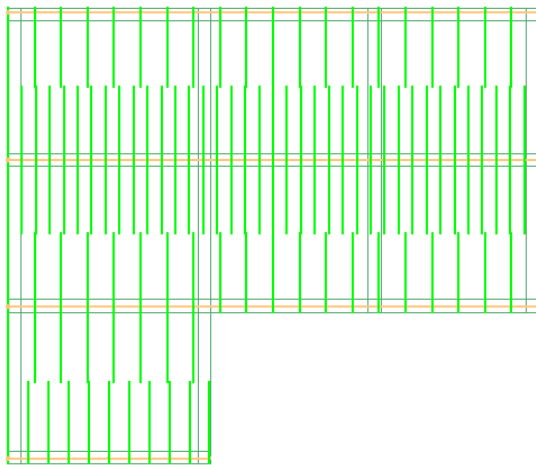
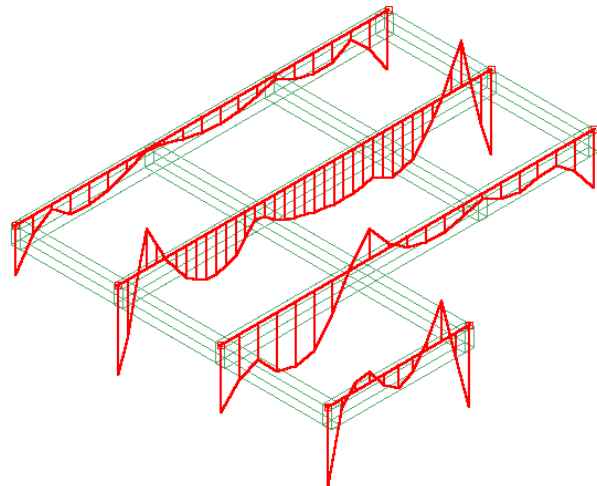

Figure 5.5-17 - Deflection of Slab for Edge Lift Equal to 0.05"



(a) Stress Check Results At Design Sections



(b) Design Strip Moments

Figure 5.5-18 - Stress Check and Design Moments for Design Strips in the Long Direction Under Edge Lift Condition

(Green color indicates that design stresses are below allowable values)

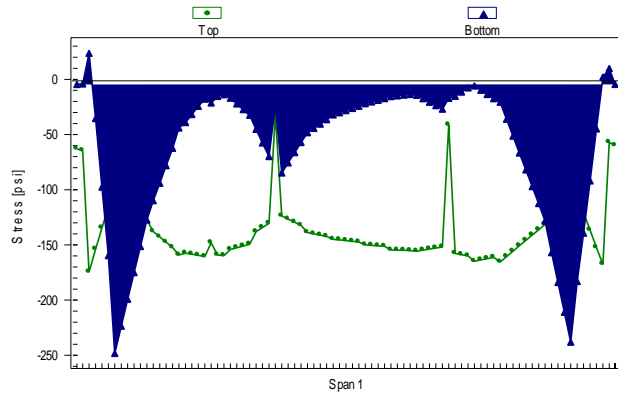

(a) Top and Bottom Fiber Stresses (Compression Negative)

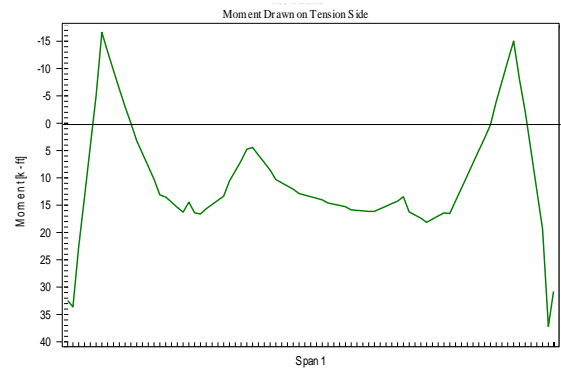

(b) Distribution of Moment (Drawn on Tension Side)

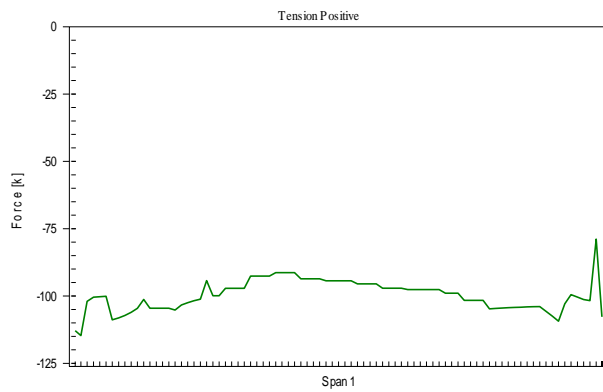

(c) Axial Force

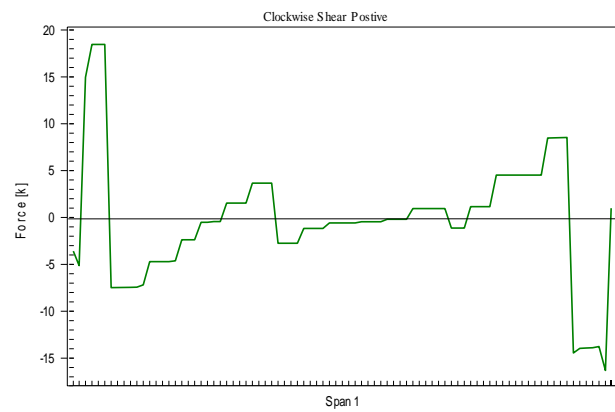

(d) Shear Force (Max Value = 18.5 K)

Figure 5.5-19 - Design Stress, Moment, Axial Force and Shear of Design Strip at Gridline 2
 (Sharp changes in stress diagram are at locations where design section is along the transverse Beam)

5.6 Comments

The following discusses some of the assumptions inherent in the PTI and E-PTI methods. To provide a more comprehensive comparison between the two methods, the design of a SOG with features that are not in the PTI examples is also presented (Figs. 5.6-1 and 5.6-2). The details of this example, an actual design, are reported in reference [Aalami, Sittman, 2002].

5.6.1 Reference Example

The following is the relevant design information:

Overall Slab dimensions: 58 ft X 105.67 ft

- Slab thickness: 4 in
- Perimeter Beam: 12x24 in
- Interior Beams: 12x20 in

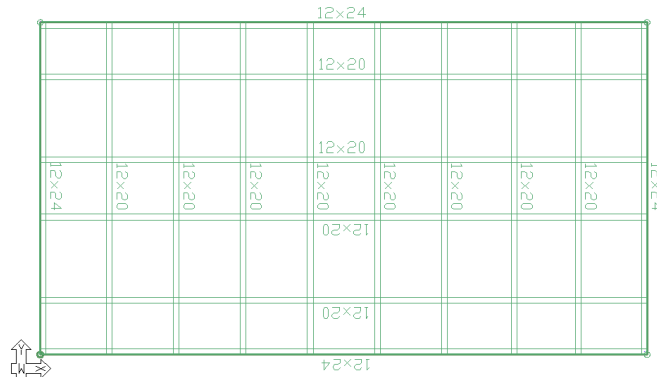

Figure 5.6-1 - Location and Dimensions of the Stiffening Beams

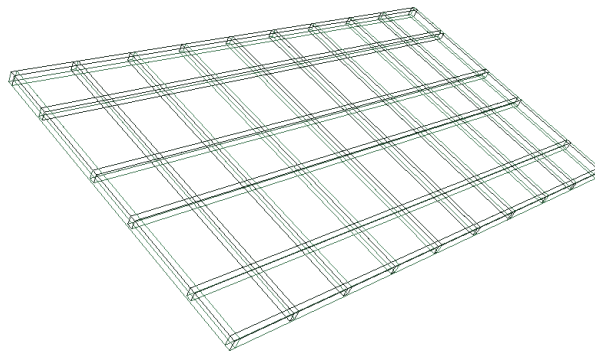

Figure 5.6-2 View of Stiffening Beams

The Slab is reinforced with 35 – ½ inch strands in the short direction and 22 – ½ inch strands in the long direction.

5.6.2 Comments on PTI and E-PTI Methods

5.6.2.1 Uniform Thickness

PTI method formulas were derived from solutions of flat plates of uniform thickness and uniform stiffness. Ribbed Slabs are approximated by Slabs uniform thickness. As a result, the effects of torsion and shear between the crossing Beams and the Slab are not accounted for. Refer to **Fig. 5.6-3** which is **Figs. B5.1 and B5.2** of reference [PTI, 1996]. The moment diagrams determined for the ribbed Slab by the PTI method have a smooth distribution. A distribution of moment for a similar scenario of the reference example is shown in **Figs. 5.6-4 and 5.6-5**. As can be seen, torsion and shear transfer at the intersection with the Beams results in abrupt changes in the diagrams.

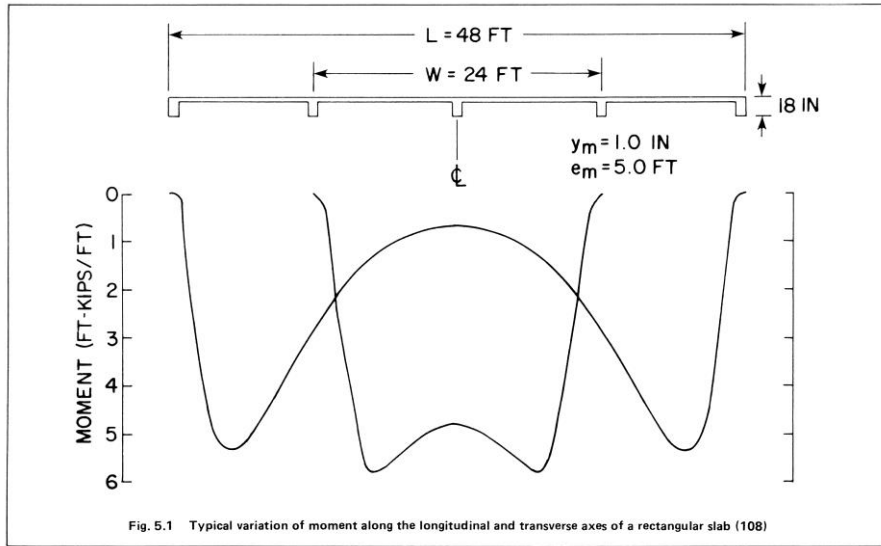

(a) PTI Distribution of Moment in the Short Direction

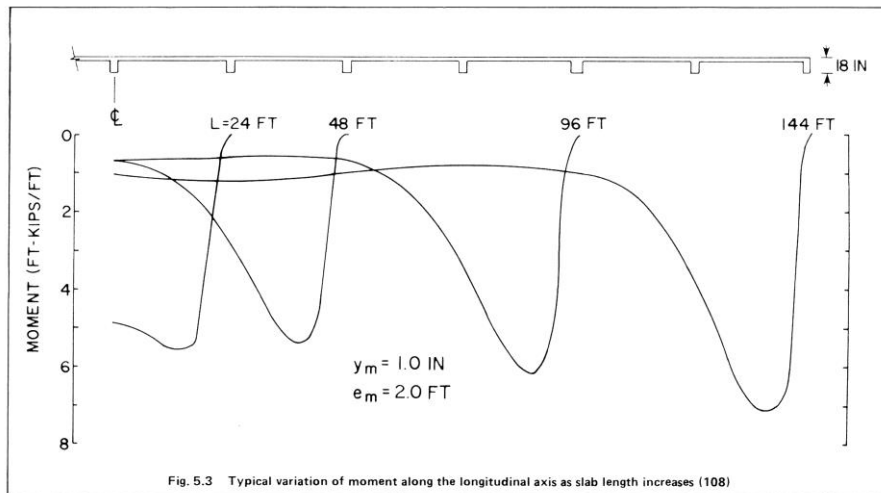

(b) PTI Distribution of Moment in the Long Direction

Figure 5.6-3 - PTI Distribution of Moment

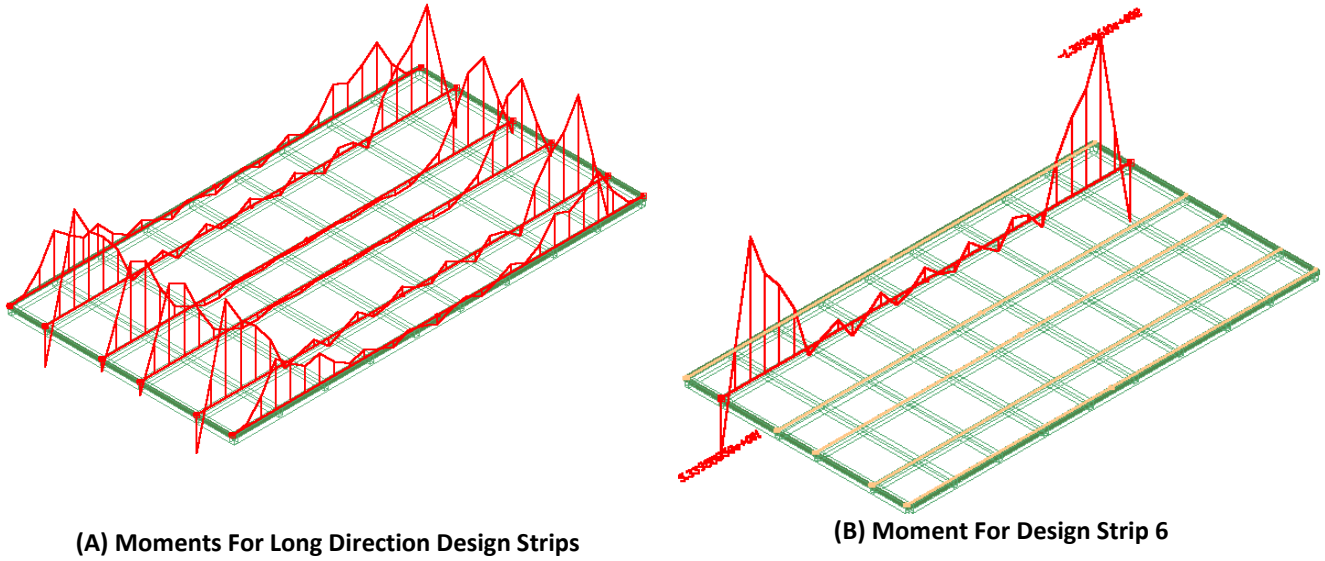

Figure 5.6-4 - Distribution of Design Strip Moments in the Longitudinal Direction

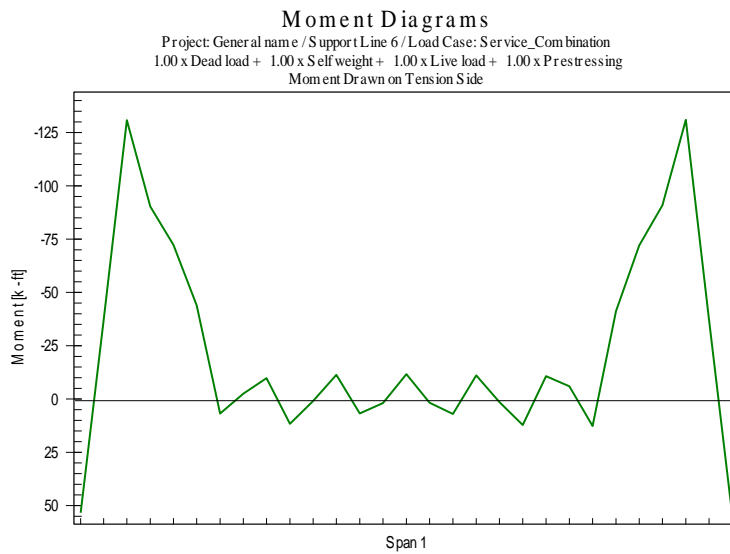

Figure 5.6-5 - Distribution of Moment for Design Strip 6
 (The positive moment at either end is due to the Tendon eccentricity at the edge Beam; the steps in the moment diagram are due to transfer of torsion at interior cross Beams.)

5.6.2.2 Straight Tendons at Centroid

In the PTI method formulas, the Tendons are assumed to be straight and anchored at the centroid of the ribbed Slab cross-section. In practice, however, the Tendons are generally anchored at the centroid of the Slab portion. This results in an eccentricity with respect to the actual cross-section. The beam Tendons are also eccentric with respect to the actual cross-section and are profiled, such as in the PTI design example reported herein. Since the Tendon profiling and eccentricity are not accounted for in PTI's formulas, the moments at the Slab edge are zero as shown in the PTI figures reproduced in **Fig. 5.6-3**. In the E-PTI solution (**Fig. 5.6-5**), however, the moments at the Slab edge are the moment generated by the eccentricity of Tendons combined with the torsional effects of the cross Beam. Slab edge moments are generally positive (**Fig. 5.6-5**).

5.6.2.3 One Soil Property for All Projects

The PTI formulas are based on only one soil property, the soil's modulus of elasticity. In addition, all soils are assumed to have a modulus of elasticity of 1000 psi. As a result, for a given y_m , e_m , and loading, the PTI method always yields the same design values. The E-PTI method accounts for variations in soil stiffness by modeling the soil through discrete Winkler springs. The denser the springs, the closer the solution is to a three-dimensional representation of the elastic properties of the soil. Design Strips can be modeled with different spring values if soil properties beneath the Slab vary.

5.6.2.4 Load on Perimeter Only

The PTI formulas only allow a uniform load on the perimeter of a Slab, the Slab selfweight, and a distributed live load of 40 psf over the entire slab. They cannot account for other loads on the Slab or different values of live loading. In most actual designs, the Slab edge is not held down by perimeter loading and the section of the Slab along the free edge can be severely affected by the edge lift condition. The E-PTI method provides flexibility in changing or even removing the loading on the Slab perimeter. In addition, loads of arbitrary magnitude and configuration can be applied anywhere on the Slab. This leads to a more realistic determination of design values.

5.6.2.5 Rectangular Slabs

The PTI formulas were derived for Slabs of rectangular geometry. In practice most Slabs, including the PTI example reviewed in this report, are non-rectangular. Extending the rectangular solution to a non-rectangular and irregular geometry involves extensive approximations.

5.6.2.6 Slabs with Minimum Width of 24 ft

The formulas in the PTI method were derived for Slabs having a minimum width of 24 ft. Application of the formulas beyond the range for which they were derived is not clear, particularly for the edge lift condition. Part of the Slab of the PTI design example reviewed in this report is 16 ft wide. The relevance of the results obtained for the 16 ft region is questionable.

5.6.2.7 One Representative Design Value

The PTI method uses one representative design value (design moment or design shear) for the entire Slab width, regardless of the Slab width or its irregularities. The representative value is derived from solutions of Slabs of uniform thickness. The E-PTI is based on representative design values for each of the Design Strips with faithful representation of the Design Strip's geometry and prestressing details. For ribbed construction, a Design Strip typically includes one Beam and its associated tributary slab width. The selection of Design Strip "representative" values in E-PTI increases the accuracy of design compared to the PTI method that uses a single "representative" value. In addition, when the Slab response at the corners is significantly different from that of the interior regions, as is the case in most design, differentiating between the strips along the Slab edge and those at the interior results in a more appropriate design.

5.6.2.8 Shear Due to Profiled Tendons

The PTI method formulas are based on straight Tendons. In many instances, beam Tendons are profiled. The shear due to profiled Tendons generally exceeds the design shear given by the PTI formula for the center lift condition by 50% or more. This discrepancy casts doubt on the validity of using the PTI method for Slabs with profiled Tendons. The E-PTI method accounts for the impact of Tendon profile in both the vertical and horizontal planes.

5.6.2.9 Check for Floating Slabs

Figure 5.6-6 is used to illustrate the concept of a floating Slab. In the PTI method, a Slab under an edge lift condition is considered to be lifted around its entire perimeter. The PTI method uses a formula to calculate Δ , the relative displacement between the perimeter of the Slab and its interior. The actual deformation of the Slab due to the applied displacement, Δ , is a function of the stiffness of the Slab and the applied loading. The final configuration will be similar to part (c) of the figure; the Slab is likely to lose contact with the soil over a band along its perimeter and will be supported by the soil at the interior.

At its hypothetical limit, the maximum deflection that a Slab can undergo, **(d)**, is if it completely loses contact with the soil and is lifted off the ground by the displacement around its perimeter (part **(b)** of the figure).

If the total relative displacement, Δ , calculated using the PTI formula is greater than the maximum deflection of the Slab under its own weight and applied load ($\Delta > d$), the Slab will completely lift off its foundation, as illustrated in part **(d)** of the figure. This condition though possible, is not likely to occur in practice. Factors beyond those considered in the PTI formula will keep the building on the ground. In many instances, however, the formulas in the PTI method subject the Slabs to deflections greater than what is needed to keep them on the ground. This was illustrated in the PTI example discussed in this report:

Unsupported Slab deflection $d = 0.27$ in
PTI method's total differential deflection $\Delta = 0.33$ in

(Total differential deflection = 0.33 in) > (Maximum Slab deflection $d = 0.27$ in)

The E-PTI method automatically checks for floating Slabs, as was illustrated for the PTI example.

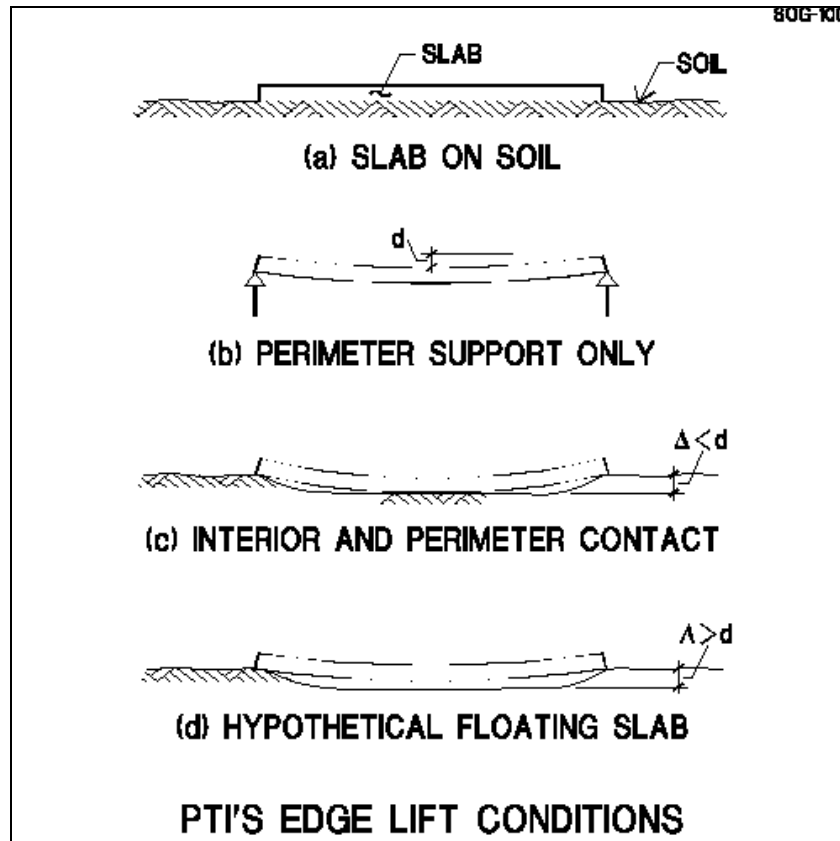

Figure 5.6-6 - PTI's Edge Lift Conditions

5.7 Concluding Remarks

The review of the PTI design method and its comparison with the E-PTI design procedure described in this report leads to the following conclusions.

- The E-PTI method can be used to simulate the PTI procedure [PTI, 1996], but has the added capability that it can also be used to eliminate some of the shortcomings inherent in the current PTI procedure.
- The E-PTI method can handle non-rectangular Slab boundaries.
- The E-PTI method can account for the profile of Tendons in the foundation Slab as well as the eccentricity of the Tendons at the edges of the foundation.
- In the E-PTI method load can be applied at the interior of the Slab at the locations and the amounts they occur.
- The loading at the Slab boundaries need not be limited to the values inherent in PTI method. The E-PTI method can handle loads outside the limitations of PTI method.
- The E-PTI method has no limitation on the width of the foundation Slab. The formulas given in the PTI method were derived for foundations with a width equal or larger than 24 ft.
- Unlike the PTI method, the E-PTI method can handle different soil properties.
- The E-PTI method can treat both uniform and ribbed slabs without the geometry approximations inherent in PTI method.
- In its shear calculation, the E-PTI method can account for the adverse and significant impact of Tendons to the shear values in the center lift condition of loading.
- The E-PTI Slab method can detect the condition of “floating” (also referred to as “flying”) foundations implicit for a range of PTI formulas, and analyze the foundation Slab on the ground.

5.8 Appendix

C. ANALYSIS AND DESIGN TOOL

The analysis and design in this report were performed using ADAPT-SOG computer program [ADAPT, 2002].

D. PTI Method [PTI, 1996] Appendix A.7

6 References

- Bowles, J. E. (1988), "Foundation Analysis and Design," McGraw Hill Book Company, New York, pp. 1004.
- IBC2000, (2000) "International Building Code," International Code Council, Inc., Falls Church, VA, pp. 756.
- PTI (1996), "Design and Construction of Post-Tensioned Slabs-On-Ground," Second Edition, Phoenix, AZ, pp. 101.
- Aalami, B.O., and Sittman, R. (2003), "Design of Post-Tensioned Slabs on Expansive Soil Using the Enhanced PTI Method," ADAPT Corporation, Redwood City, CA, www.adaptsoft.com, pp. 42.
- UBC (1997), "Uniform Building Code," International Conference of Building Officials, Whittier, CA 90601, Vol.2, pp. 492.
- Aalami, B. O., and Sittman, R. L., (2002) "Post-Tensioned Slabs on Ground – Structural Design Example for Ribbed Slab on Expansive Soil", ADAPT Corporation Report, www.adaptsoft.com, September 2002.
- Aalami, Bijan, O., and Kelley, Gail, S. (2001), "Design of Concrete Floors with Particular Reference to Post-Tensioning", Post-Tensioning Institute, Phoenix, AZ, Technical Note 11, January 2001, pp 16.
- Aalami, B. O. (2001) "Software for the Design of Concrete Buildings," American Concrete Institute, Concrete International Journal, December 29, 2001, pp. 28-35.
- Aalami, Bijan, O. (2000), "Structural Modeling of Post-Tensioned Members," American Society of Civil Engineers, Structural Journal, February 2000, pp. 157-162.
- ADAPT-SOG, (2002), "A computer program for the design of ground supported slabs on expansive soil, with or without post-tensioning.", ADAPT Corporation, Redwood City, Ca, www.adaptsoft.com.
- Bowles, J. E. (1988), "Foundation Analysis and Design", McGraw-Hill Book Company, New York, pp.1004.
- PTI, (1996), "Design and Construction of Post-tensioned Slabs-on-Ground", Second Edition, Phoenix, AZ.
- Wray, W. K., (1978), "Development of a Design Procedure for Residential and Light Commercial Slabs-on-Ground Constructed Over Expansive Soils", PhD Dissertation, Texas A&M.